

With the AC3 Next range, you can wash up to 324 racks and 5832 dishes per hour. The Multirinse patented system revolutionizes the rinsing stage and considerably reduces water consumption to just 0.5 litres per rack. Thanks to multi-stage technology, Comenda creates a new, reduced PH rinsing area with 2 active tanks separated by a draining area, where the clean water is reused as much as three times over. This allows water to be saved and consequently detergent and rinse aid consumption to be reduced as well. This technology allows you to save up to 75% of water and detergent. The Next series is simple to use and service. The intuitive operation of the machine is operator-friendly. The AC3 Next is designed to make daily operations easier with deep drawn tanks, self draining wash pumps and easy to remove filters and manifolds.



Key features

Output(Min) - 1st Speed.....	230 racks/hour	Power Supply	415V 3N 50Hz 80A 3 Phase (not plugged)
Output(DIN10510) - 2nd Speed.....	255 racks/hour	Frequency	50/60Hz
Output(Max) - 3rd Speed.....	344 racks/hour	Installed Load (Hot Water)	42.1kW •
Rinse Water Consumption.....	0.5L/rack	Installed Load (Cold Water).....	50.1kW •
Tank Capacity	268 litres	Sensible Capacity	7kW
Total Length.....	4300mm	Latent Capacity	5.3kW
Water Temp Supply	55°C	Drain.....	50mm ø
Water Connection.....	2-4 Bar, 3/4"		

Standard features

- AISI 304 stainless steel tank chassis and paneling
- Double skin insulated inspection doors with integral balancing springs
- Stainless steel upper and lower inspectable washing manifolds with negative embossed antidrip nozzles
- Deep-drawn tanks with rounded corners
- Self-draining vertical pumps
- Door wipe seal automatically cleans when opening and shutting the door
- Whole tank stainless steel filter and pump suction filter
- Color Coding - Each module, along with its internal removable components, is identified by a color. This helps in cleaning operations and machine preparation process, avoiding incorrect combinations and malfunctioning.
- Prewash ON/OFF - By pressing the button on the Back-lit control panel, it's possible to activate or deactivate the Prewash.
- Sequence Control - During machine installation, this procedure allows to check electrical phase and 3 phase motor correct rotation.
- PST - External conveyor connection to machine. Allows machine electrical connection to any automatic infeed or exit conveyor systems.
- HPS EASY - A dedicated display enables the operators to keep a daily check on water and energy consumption, usage time and to be advised on any operational default.
- Upper back-lit control panel with digital display temperature readout
- 3 speeds - Inverter
- Inlet Splash shield
- 24V control circuit
- Economizer that activates rinsing only when rack passes through
- Electrical setup for connection of dosing devices for chemicals
- Machine side disconnection switch
- Digital water flowmeter with total rinse water consumption and machine run time
- All prewash sections with inspection door
- EOR - Emergency Override Key activated electromechanical emergency function. If an electronic malfunction occurs, the EOR ensures the machine drive system, wash pumps and heating elements continue to operate so you can organize servicing at a time that is most convenient for your operation.
- APRS® Automatic Proportional Rinse System (Autotimer Automatic Reset included) Patented system which allows to reduce up to 30% dishwasher consumptions adapting automatically the water, energy and chemicals according to the work load.
- APWS - Automatic Proportional Wash System: it modulates automatically the flow rate and volume of water according to the selected wash speed.

Standard Configuration

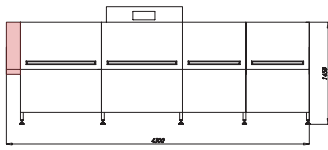

Splash Shield

The entry splash shield prevents splashing of water to the exterior of the machine.

Module Length.....200mm

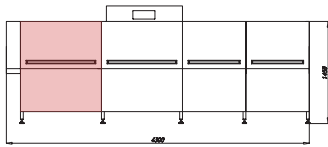

PreWash

In this zone food residue is removed thanks to the large circulation pump and the easily extractable upper and lower manifold.

Module Length.....1150mm

Wash Pump.....1.24kW

Tank Heater.....10kW

Tank Volume80L

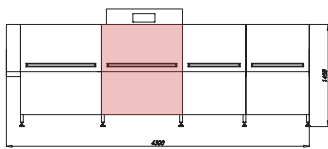

APWS Wash

In this zone food residue is removed thanks to the combined action of detergent and large circulation pump together with easily extractable upper and lower manifold.

Module Length.....1150mm

Wash Pump.....1.24 + 0.85kW

Tank Heater.....14kW

Tank Volume80L

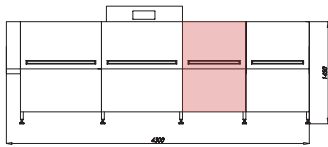

Wash

In this zone food residue is removed thanks to the combined action of detergent and large circulation pump together with easily extractable upper and lower manifold.

Module Length.....900mm

Wash Pump.....1.24kW

Tank Heater.....12kW

Tank Volume80L

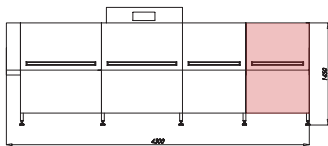

MultiRinse®

This patented multistage rinsing system significantly reduces water consumption.

Module Length.....900mm

Wash Pump.....2 x 0.48kW

Tank Heater.....6.0kW

Tank Volume2 x 14L

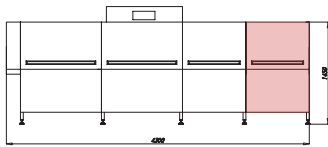

Final Rinse

In this zone, the dishware is rinsed with fresh hot water.

Rinse Water Flow (@ DIN Speed).....115 L/Hour

Rinse Water Flow (@ Maximum Speed).....172 L/Hour

Booster Heater (@ 55°C).....10.0kW •

Booster Heater (@ 15°C).....18.0kW •

Accessories

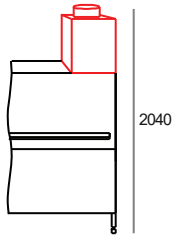

RC - Heat Recovery Unit

Fitted on the rinse section, it enables the machine to be connected to cold water, which is pre-heated and transferred to the rinse booster.

Total Installed Load Becomes (Cold Water Connection).....	44.15kW	•
Fan Power Output.....	0.047kW	
Sensible Capacity.....	6.6kW	
Latent Capacity.....	5.7kW	
Single Point Air Extraction.....		

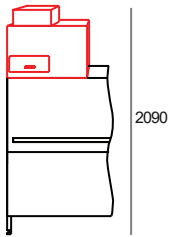

WP7.1L - Heat Pump for One Tank Heating

The heat pump heats the water in the wash tank with higher efficiency than the electrical heating element.

Total Installed Load Becomes (Hot Water Connection).....	33.3kW	•
Total Installed Load Becomes (Cold Water Connection).....	41.3kW	•
Sensible Capacity.....	4.4kW	
Latent Capacity.....	0.3kW	
Single Point Air Extraction.....		

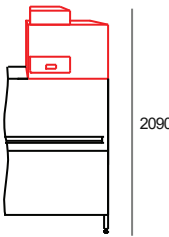

WP7.2 - Heat Pump for One Tank Heating and Rinse Water Preheating

The heat pump heats the water in the wash tank and rinse water rinse with higher efficiency than the electrical heating element.

Total Installed Load Becomes (Cold Water Connection).....	35.2kW	•
Sensible Capacity.....	4.4kW	
Latent Capacity.....	0.3kW	
Single Point Air Extraction.....		

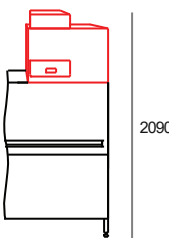

WP7.3 - Heat Pump for Two Tank Heating and Rinse Water Preheating

It preheats final rinse water allowing machine connection to cold water, with a reduced connected load. It heats two wash tanks.

Total Installed Load Becomes (Cold Water Connection).....	25.2kW	•
Sensible Capacity.....	5.6kW	
Latent Capacity.....	0.3kW	
Single Point Air Extraction.....		

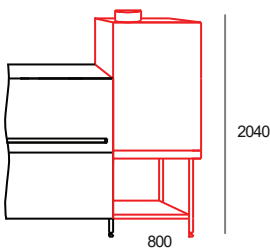

ARC8 - 800 mm ARC Blower Dryer with Heat Recovery Unit

It allows the hot and humid air flow created inside the machine to be utilized.

Total Installed Load Becomes (Cold Water Connection).....	50.63kW	•	
Module Length.....	800mm		
Sensible Capacity.....	8.9kW	Latent Capacity.....	8.8kW
Dryer Fan Power Input.....	0.42kW	Dryer Heater.....	6.0kW
Single Point Air Extraction.....			

Accessories

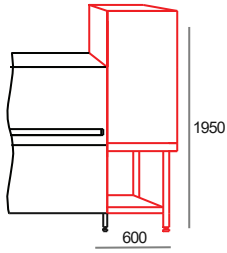

AS6 - 600 mm Blower Dryer

The air for the dryer is heated in a battery with heaters and blown on the dishware by means of a double jet.

Module Length.....	600mm
Dryer Fan Power Input.....	0.42kW
Dryer Heaters.....	6.0kW
Sensible Capacity.....	10.5kW
Latent Capacity.....	9.3kW

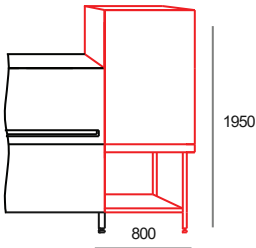

AS8 - 800 mm Blower Dryer

The air for the dryer is heated in a battery with heaters and blown on the dishware by means of a double jet.

Module Length.....	800mm
Dryer Fan Power Input.....	0.42kW
Dryer Heaters.....	6.0kW
Sensible Capacity.....	10.5kW
Latent Capacity.....	9.3kW

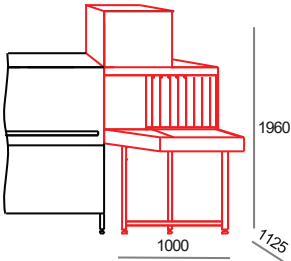

TC90 - AS Blower Dryer on 90° exit curve without motor

The dryer is fitted on a 90° curve to optimize working space in the washing area.

Module Length.....	1000 x 1125mm
Dryer Fan Power Input.....	0.42kW
Dryer Heaters.....	6.0kW
Sensible Capacity.....	10.5kW
Latent Capacity.....	9.3kW

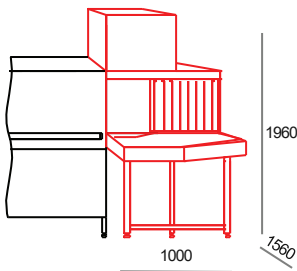

TC180 - AS Blower Dryer on 180° exit curve with motor

The dryer is fitted on a 180° motorized curve to optimize working space in the washing area.

Module Length.....	1000 x 1560mm
Dryer Fan Power Input.....	0.57kW
Dryer Heaters.....	6.0kW
Sensible Capacity.....	10.5kW
Latent Capacity.....	9.3kW

Accessories

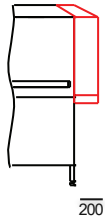

Splash Shield

The exit splash shield prevents splashing of water to the exterior of the machine.

Module Length.....200mm

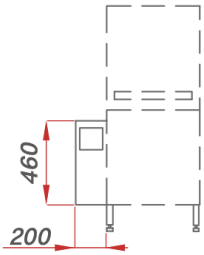

RED Automatic Soil Removal

The soiled particles are pumped out from the prewash module to the 200mm external module, keeping the prewash water clean.

Module Length.....200m

Wash Recycle Pump 2 x 0.10kW

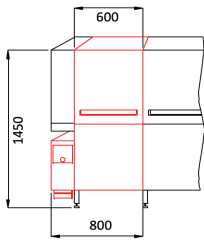

DHM 2+ - Automatic Pre-Scraping System + RED Automatic Soil Removal

600mm prewash section c/w pump and external filtering system (RED), removable with machine in operation (no downtime).

Module Length.....600m

Wash Pump 0.99kW

Tank Volume 45L

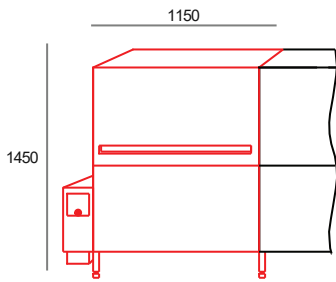

P-MAX – Automatic pre-scrap, pre-wash module with DHM and RED systems integrated

1150 mm module with integrated DHM upper arm, PWS technology and automatic soil removal (RED).

Module Length.....1150m

Wash Pump 0.99kW

Tank Volume 80L

Options

Central Drain

Any single tank drain is connected together in a central drain.

C-Smart

Comenda C-Smart features an advanced IP65 rated electronic touch screen control and, at the same time, an auxiliary system EOR (Emergency OverRide), granting uncompromising washing results with the lowest possible running costs. Simple, intuitive, universal, the EOR allows even unskilled staff to operate the unit in a basic but efficient mode and cope with unexpected PCB failures during operations granting consistency with no downtime – C-Smart allows for Wi-Fi connection and remote connection through the VPN Gateway via computer, tablet or smartphone to access maintenance related data with the opportunity for remote fault finding and servicing.

HPS EASY

A dedicated display enables the operators to keep a daily check on water and energy consumption and usage time to be advised on any operational fault.

HPS EASY PLUS

To store HACCP data on internal memory and copy them on a USB memory stick.

RAH Rinse Aid Homogenizer

It uniformly mixes rinse water and rinse agent. Reducing rinse aid consumption by 70%.

RCD Rinse Control Device

It combines an atmospheric booster and a rinse booster pump and ensures rinsing at a constant temperature and pressure throughout the cycle.

AC3N-45LR

RACK CONVEYOR DISHWASHING MACHINE – AC3 45 NEXT

DHM 2+ – Automatic Pre-Scrapping System + RED Automatic Soil Removal

The three upper arms with different jet patterns, combined with the lower 6-nozzle- washing arm replicate the action of manual pre-washing by performing an energetic removal of dirt. The DHM2 + module eliminates the need for manual prewash and guarantees a controlled water consumption and dramatic water savings.

P-MAX – Automatic prewash module with DHM and RED systems integrated.

The 8 upper and lower arms with different jet patterns and different projection angles, attack food residues through three different actions: Hydration – Detachment – Elimination. The 4 PWS arms completely remove dirt from the dishes, preparing them for the degreasing action of the wash. The residues are then conveyed outside the machine and collected into the RED filter.

Rinse Aid Injector

Liquid Detergent Injector

Thermolabel test Compliance (full technical spec)

Drain pumps

Splash shield with collars

Special voltages

230V 3~ 50 Hz
230V 3~ 60 Hz
440V 3~ 60 Hz
480V 3~ 60 Hz

Marine execution

Installation Drawing

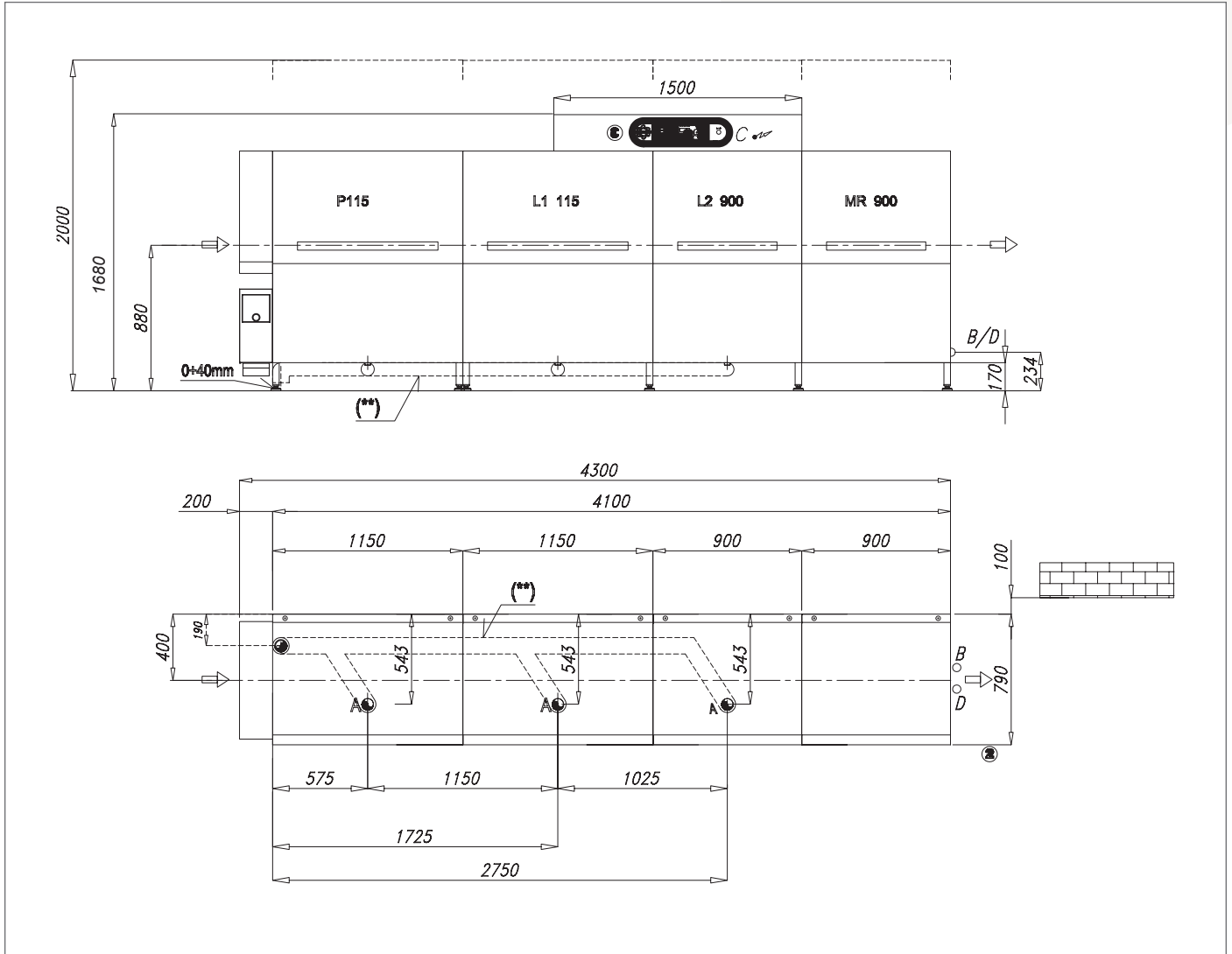

The drawing refers to the standard machine with no optional - Feeding direction: left / right

Please enquire for the installation drawing relevant to the configuration selected.

Comcater Pty Ltd reserves the right to modify product specifications at any time without prior notice.