







Optionals

-  OZONE
-  HACCP USB
-  WATER COOLED CONDENSER
-  VERTICAL CONTROL PANEL
-  ADDITIONAL INSTALLATION KIT
-  SOUNDPROOF CONDENSING UNIT
-  400 mm TUNNEL LENGTH EXTENSION



Capacity



1230 kg
+90°C → +3°C



1120 kg
+90°C → -18°C

6

Trolleys
800 x 850 mm

16

Trolleys
450 x 650 GN

Features

Code number	MT6	MT6 1/2
Power supply	400V/3N/50HZ	400V/3N/50HZ
Outside length	2230 / 980 mm	2230 / 980 mm
Depth	5030 / 4830 mm	5430 / 5230 mm
Height	2630 / 2080 mm	2630 / 2080 mm
Capacity 800x850 mm / 450x650 GN	6 / 14	6 / 16
Output chilling (+90°C/+3°C)	1230 kg	1230 kg
Output freezing (+90°C/-18°C)	1120 kg	1120 kg
Electronic card	BASE	BASE
Absorbed power	42 kW	42 kW

REMOTE UNIT FEATURES (MAX DISTANCE 15 M)

Power supply	400V/3N/50HZ	400V/3N/50HZ
Refrigeration Power (Cond:-20°/+40 (°C))	79,40 kW - 27+27 HP	79,40 kW - 27+27 HP
Absorbed power (Cond:-20°/+40 (°C))	39 kW	39 kW
Diameter Discharge Pipe (<15 mt)	22-22 mm	22-22 mm
Diameter Suction Pipe (<15 mt)	54-54 mm	54-54 mm
Diameter Hot Gas Pipe (<15 mt)	22-22 mm	22-22 mm
Gas	R 452a (GWP2141)	R 452a (GWP2141)
Dimensions	2200 x 1300 x 1850 mm	2200 x 1300 x 1850 mm

Dimensions

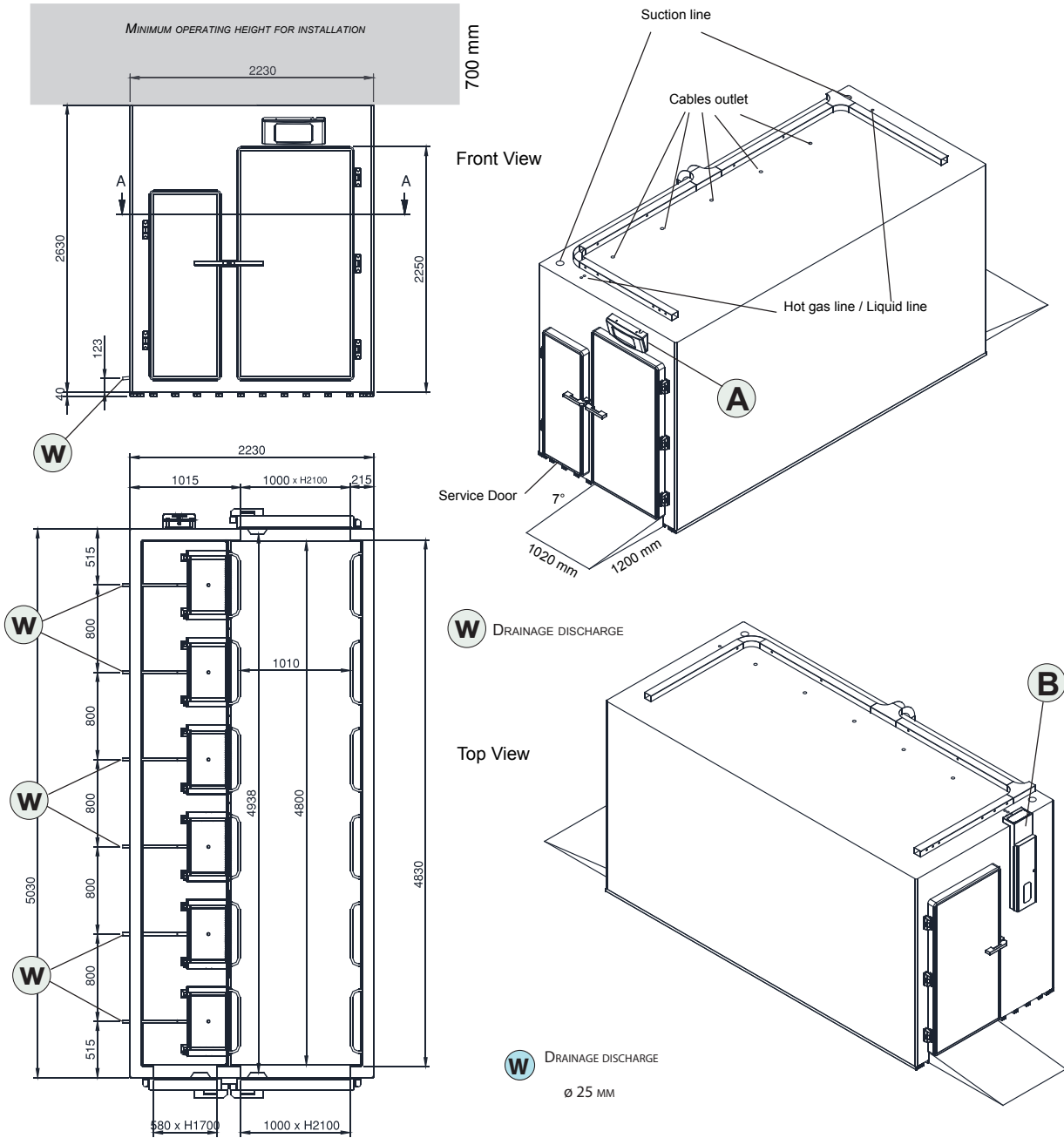

For running 24 hours a day

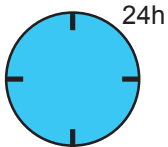

Excavation example

Excavation Section

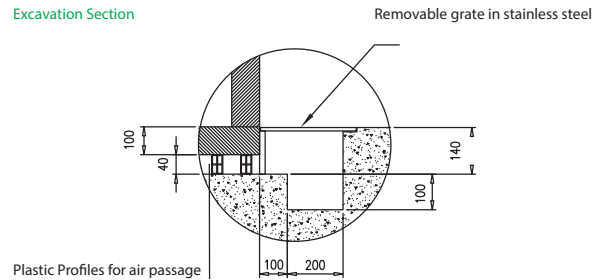

Alternative solutions Control Panel Position

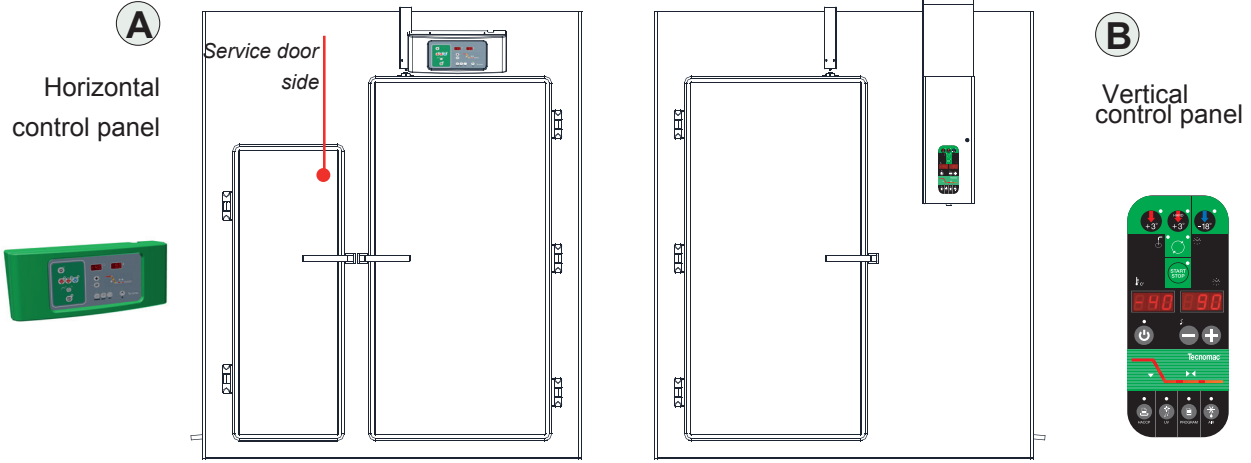

REMOTE UNIT FEATURES

Machine delivered without condensing unit - Disclaimer Clause

Castelmac guarantees only the good functioning of the components of the machine. It's excluded from the warranty:

- the cooling performance of the machine
- malfunctioning or damages due to the partial or not complete connection of the machine with the central cooling unit or the not original condensing unit. In particular there is no warranty on damages on the machine due to the missed connection of the alarm input which stops the machine in case of alarm coming from the central cooling unit or the not original condensing unit. Hot gas defrosting available only if hot gas supplied (distance < 25 m). Alternative air defrosting available from control panel.

CONNECTION TO CENTRAL COOLING UNIT

- Blast Freezing function must be disabled (do not work)
- Use the freezing line (-28°C / -30°C Evaporation)
- Output signal supplied for liquid line valve control (valve not supplied)
- Input signal available for general alarm from the central cooling unit, which stops the machine

CONNECTION TO CONDENSING UNIT NOT SUPPLY BY TECNOMAC

- Output signal supplied for switch on compressor
- Output signal supplied for switch on hot gas valve (if present)
- Input signal available for alarm coming from the condensing unit, which stops the machine

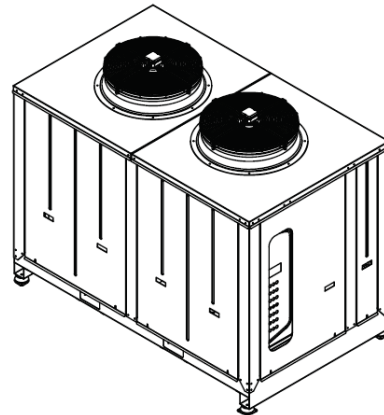

CONDENSING UNIT WITH BOX