

# Operating Instructions

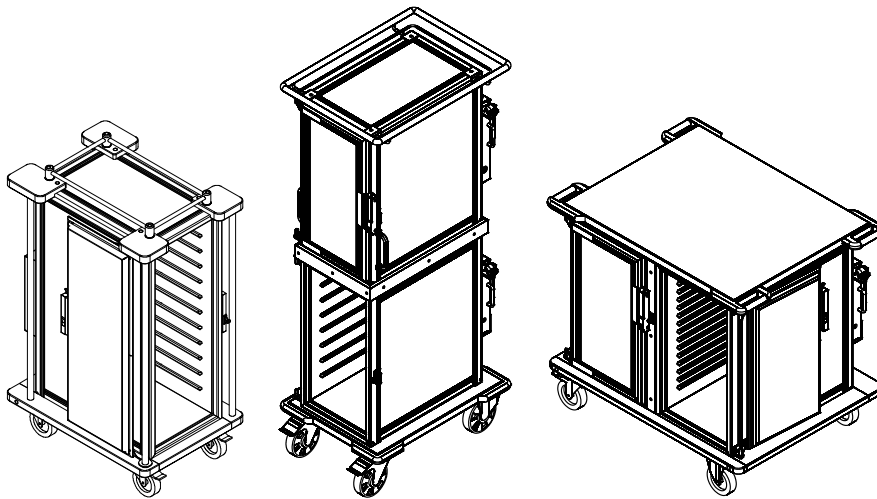

**ISOBOX® Mobil**

# 1 Introduction

---

## 1.1 Appliance Information

---

Appliance designation	ISOBOX® Mobil
Appliance type/ -s	
Manufacturer	HUPFER® Metallwerke GmbH & Co. KG Dieselstrasse 20 48653 Coesfeld  P.O. Box 1463 D-48634 Coesfeld  ☎ +49 2541 805-0 📠 +49 2541 805-111  <a href="http://www.hupfer.de">www.hupfer.de</a> <a href="mailto:info@hupfer.de">info@hupfer.de</a>

Read and understand these operating instructions to ensure safe operation and avoid any damage!  
Ensure that sources of danger and possible faulty operations have been pointed out to the operating staff.

### **Subject to modifications**

The products covered by these operating instructions have been developed taking into consideration the requirements of the market and the latest technology. HUPFER® reserves the right to modify the products and related technical documentation in the interests of technical progress. The data and weights as well as the description of performance and functions assured in the order confirmation as binding are always decisive.

**This manual is an original edition.**

**Manual edition**  
91285373\_A0

## 1.2 Table of Contents

---

<b>1</b>	<b>Introduction</b>	<b>2</b>
1.1	Appliance Information	2
1.2	Table of Contents	3
1.3	List of Abbreviations	5
1.4	Definitions of Terms	6
1.5	Orientation Guide	7
1.6	Notes on Use of Manual	8
1.6.1	Notes on the Manual Structure	8
1.6.2	Notes and their Illustrations used in the Chapters	8
<b>2</b>	<b>Safety Instructions</b>	<b>9</b>
2.1	Introduction	9
2.2	Warning Symbols Used	9
2.3	Safety Instructions for Appliance Safety	9
2.4	Safety Instructions for Transport	10
2.5	Safety Instructions for Cleaning and Care	10
2.6	Safety Instructions for Troubleshooting	11
2.7	Notes on Specific Hazards	11
<b>3</b>	<b>Description and Technical Data</b>	<b>12</b>
3.1	Performance Description	12
3.2	Proper Use	12
3.3	Improper Use	12
3.4	Appliance Description	13
3.4.1	View of the appliance	13
3.4.2	Appliance Description	13
3.4.3	Equipment and optional accessories	14
3.5	Technical Data	14
3.6	Rating Plate	16
<b>4</b>	<b>Transport, Putting into Operation and Decommissioning</b>	<b>17</b>
4.1	Transport	17
4.2	Putting into Operation	17
4.3	Storage and Recycling	18
<b>5</b>	<b>Operation</b>	<b>19</b>
5.1	Arrangement and Function of the Operating Elements	19
5.2	Operation	20
5.3	Measures at the End of Operation	21
<b>6</b>	<b>Troubleshooting and Repair</b>	<b>22</b>
6.1	Safety Measures	22
6.2	Notes on Troubleshooting	22
6.3	Fault and Action Table	22

<b>7</b>	<b>Cleaning and Care</b>	<b>24</b>
7.1	Safety Measures	24
7.2	Hygiene Measures	24
7.3	Cleaning and Care	24
7.4	Special Care Instructions	25
<b>8</b>	<b>Spare Parts and Accessories</b>	<b>26</b>

## 1.3 List of Abbreviations

Abbreviation	Definition																																				
BGR	Employer's Liability Insurance Association																																				
BGV	Regulation of the Professional Association																																				
CE	Communauté Européenne European Community																																				
DIN	Deutsches Institut für Normung German Institute for Standardisation, technical regulations and technical specifications																																				
EC	European Community European Union																																				
EN	European Standard Harmonised standard for the EU market																																				
E/V	Spare and wearing part																																				
IP	<p>International Protection. The abbreviation IP and a further two-digit index specify the protection class of a housing.</p> <p>The first digit: Protection against ingress of solid foreign objects      The second digit: Protection against ingress of water</p> <table border="1"> <tbody> <tr> <td>0</td> <td>No protection against contact, no protection against ingress of solid foreign objects</td> <td>0</td> <td>No protection against ingress of water</td> </tr> <tr> <td>1</td> <td>Protection against contact with any large surface of the body such as the hand, protection against ingress of foreign objects <math>\varnothing &gt; 1.97''</math> (50 mm)</td> <td>1</td> <td>Protection against dripping water (vertically falling drops)</td> </tr> <tr> <td>2</td> <td>Protection against contact with fingers, protection against foreign objects <math>\varnothing &gt; 0.47''</math> (12 mm)</td> <td>2</td> <td>Protection against dripping water (at any angle up to 15° from the vertical)</td> </tr> <tr> <td>3</td> <td>Protection against contact with tools, thick wires or similar objects of <math>\varnothing &gt; 0.1''</math> (2.5 mm), protection against foreign objects <math>\varnothing &gt; 0.1''</math> (2.5 mm)</td> <td>3</td> <td>Protection against water drips at any angle up to 60° from the vertical</td> </tr> <tr> <td>4</td> <td>Protection against contact with tools, thick wires or similar objects of <math>\varnothing &gt; 0.04''</math> (1 mm), protection against foreign objects <math>\varnothing &gt; 0.04''</math> (1 mm)</td> <td>4</td> <td>Protection against water splashing from any direction</td> </tr> <tr> <td>5</td> <td>Protection against contact, protection against dust deposits inside</td> <td>5</td> <td>Protection against water jets (projected by a nozzle) at any angle</td> </tr> <tr> <td>6</td> <td>Complete protection against contact, protection against ingress of dust</td> <td>6</td> <td>Protection against rough sea or strong water jets (flood protection)</td> </tr> <tr> <td></td> <td></td> <td>7</td> <td>Protection against ingress of water during temporary immersion</td> </tr> <tr> <td></td> <td></td> <td>8</td> <td>Protection against pressurised water during continuous immersion</td> </tr> </tbody> </table>	0	No protection against contact, no protection against ingress of solid foreign objects	0	No protection against ingress of water	1	Protection against contact with any large surface of the body such as the hand, protection against ingress of foreign objects $\varnothing > 1.97''$ (50 mm)	1	Protection against dripping water (vertically falling drops)	2	Protection against contact with fingers, protection against foreign objects $\varnothing > 0.47''$ (12 mm)	2	Protection against dripping water (at any angle up to 15° from the vertical)	3	Protection against contact with tools, thick wires or similar objects of $\varnothing > 0.1''$ (2.5 mm), protection against foreign objects $\varnothing > 0.1''$ (2.5 mm)	3	Protection against water drips at any angle up to 60° from the vertical	4	Protection against contact with tools, thick wires or similar objects of $\varnothing > 0.04''$ (1 mm), protection against foreign objects $\varnothing > 0.04''$ (1 mm)	4	Protection against water splashing from any direction	5	Protection against contact, protection against dust deposits inside	5	Protection against water jets (projected by a nozzle) at any angle	6	Complete protection against contact, protection against ingress of dust	6	Protection against rough sea or strong water jets (flood protection)			7	Protection against ingress of water during temporary immersion			8	Protection against pressurised water during continuous immersion
0	No protection against contact, no protection against ingress of solid foreign objects	0	No protection against ingress of water																																		
1	Protection against contact with any large surface of the body such as the hand, protection against ingress of foreign objects $\varnothing > 1.97''$ (50 mm)	1	Protection against dripping water (vertically falling drops)																																		
2	Protection against contact with fingers, protection against foreign objects $\varnothing > 0.47''$ (12 mm)	2	Protection against dripping water (at any angle up to 15° from the vertical)																																		
3	Protection against contact with tools, thick wires or similar objects of $\varnothing > 0.1''$ (2.5 mm), protection against foreign objects $\varnothing > 0.1''$ (2.5 mm)	3	Protection against water drips at any angle up to 60° from the vertical																																		
4	Protection against contact with tools, thick wires or similar objects of $\varnothing > 0.04''$ (1 mm), protection against foreign objects $\varnothing > 0.04''$ (1 mm)	4	Protection against water splashing from any direction																																		
5	Protection against contact, protection against dust deposits inside	5	Protection against water jets (projected by a nozzle) at any angle																																		
6	Complete protection against contact, protection against ingress of dust	6	Protection against rough sea or strong water jets (flood protection)																																		
		7	Protection against ingress of water during temporary immersion																																		
		8	Protection against pressurised water during continuous immersion																																		
LED	Light Emitting Diode Light diode																																				

## 1.4 Definitions of Terms

Term	Definition
Authorised specialist	An authorised specialist is a specialist that has been trained by the manufacturer, an authorised service dealer or a company assigned by the manufacturer.
Cook&Chill Kitchens	"Cook and Chill": Kitchens where warm food after being cooked is chilled as quickly as possible.
Cook&Serve Kitchens	"Cook and Serve": Kitchens where warm food is served immediately after being cooked or kept warm until it is consumed.
EM field	Electrical, magnetic or electromagnetic field that is defined by its field intensity and phase formation.
EN tray	A European standard tray is a tray with a standard size. EN 1/1 corresponds to 20.9x14.6" (530x370 mm), EN 1/2 corresponds to 11.2x10.4" (285x265 mm).
Specialist	A specialist is a person who can evaluate work assigned and can individually recognise any possible dangers due to professional training, specialist knowledge and experience as well as knowledge of the respective guidelines.
Gastronorm	Gastronorm is a measurement system applied worldwide, for instance, in food processing plants or large-scale kitchens. The use of standardised sizes makes it possible to exchange food pans. The basic size of the Gastronorm (GN) 1/1 is 20.9x12.8" (530x325 mm). Items are available in different depths.
H1	Hygienic standard (NSF/USDA) for lubricants that are suitable for incidental and technically unavoidable contact with foodstuffs
Control	Compare with certain conditions and/or characteristics such as damage, leaks, filling levels, heat.
Machine safety	The term of machine safety means all the measures used to avert injury to persons. The basis for this are national as well as EC-wide valid directives and laws for protecting users of technical devices and systems.
Passive layer	A non-metallic protective layer on a metallic material that prevents or slows down material corrosion.
Check	Compare with certain values such as weight, torque, content, temperature.
Qualified person, qualified personnel	Qualified personnel are persons who due to their professional training, experience and instruction as well as their knowledge of the respective standards, guidelines, accident prevention regulations and operating conditions have been authorised by a person responsible for system safety to carry out required activities and can recognise and prevent any possible danger (definition of specialists according to IEC 364).
Schuko®	The abbreviation of the German term "Protective contact" that indicates a system of domestic plugs and sockets equipped with protective earthed contacts used in most of Europe.
Instructed persons	An instructed person is a person who has been instructed on the possible risks resulting from improper behaviour when carrying out the assigned task as well as on the necessary protective equipment and protective measures and trained for this task if necessary.
VESKA standard	Trays as per the VESKA standard are items used for distributing food in hospitals, principally in Switzerland; they measure 20.9x14.8" (530x375 mm).

## 1.5 Orientation Guide

---

### **The front**

"The front" means the side where the appliance is loaded.

### **The rear**

"The rear" denotes the opposite side of the front side (the front). This is where the energy modules and the blind cover are inserted.

### **The right**

"The right" denotes the right hand side when viewed from the front side (front).

### **The left**

"The left" denotes the left hand side when viewed from the front side (front).

## 1.6 Notes on Use of Manual

---



### 1.6.1 Notes on the Manual Structure

This manual is structured in functional and task orientated chapters.

### 1.6.2 Notes and their Illustrations used in the Chapters

The warnings and notes are separated from the other text and particularly marked by corresponding icons. The icon cannot, however, replace the text of the safety instructions. Therefore, always read thoroughly the full text of the safety instructions. The warnings and notes are separated in these operating instructions as follows and categorised by the following danger levels by means of various symbols.

---

<b>DANGER</b>	<b>Brief description of danger</b>
	<p>There is an imminent danger to life and limb of the user and / or third parties when the instructions are not followed precisely or the circumstances described are not taken into account.</p> <p>The type of danger is indicated by a symbol and explained in the accompanying text in more detail. The general symbol for danger is used in this example.</p>
<b>WARNING</b>	<b>Brief description of danger</b>
	<p>There is an indirect danger to life and limb of the user and / or third parties when the instructions are not followed precisely or the circumstances described are not taken into account.</p> <p>The type of danger is indicated by a symbol and explained in the accompanying text in more detail. The general symbol for danger is used in this example.</p>
<b>ATTENTION</b>	<b>Brief description of danger</b>
	<p>There is a potential risk of injury or damage to property when the instructions are not followed precisely or the circumstances described are not taken into account.</p> <p>The type of danger is indicated by a general symbol and explained in the accompanying text in more detail. The general symbol for danger is used in this example.</p>
<b>NOTE</b>	<b>Brief description of additional information</b>
	<p>Attention is pointed to special conditions or additional important information on the respective subject.</p>
<b>INFO</b>	<b>Short title</b>
	<p>Contains additional information on work assisting features or recommendations on the respective subject.</p>

---



## 2 Safety Instructions

---

### 2.1 Introduction

---

The chapter on safety instructions describes the risks associated with the appliance in terms of product liability (according to the EU Directives).

The safety instructions should warn of hazards and help to avoid damages to persons, the environment and property. Please make sure that you have read and understood all the safety instructions given in this chapter.

You must comply with the respectively valid national and international Safety at Work Regulations. The manager is responsible for the valid regulations he/she has to provide. He/she must acquaint himself/herself and the operator with the new regulations.



In addition to these operating instructions, comply with the rules on health and safety at work issued by the Main Association of the industrial Professional Associations, especially with those that concern the handling of hot items and risks involved (BGR 110 "Protection of health and safety at work in restaurants" and BGR 111 "Protection of health and safety at work in large-scale kitchens").

### 2.2 Warning Symbols Used

---

Symbols are used in these operating instructions to point out the dangers that can occur while operating or cleaning the appliance. In both cases, the symbol provides information on the type and circumstances of danger.

The following symbols can be used:

	General hazardous area
	Hazardous electrical voltage
	Risk of hot surfaces

---

### 2.3 Safety Instructions for Appliance Safety

---

Safe operation of the appliance depends on appropriate and thorough use. Negligent handling of the appliance can lead to danger to life and limb of the user and / or third parties as well as hazards to the appliance itself and the other operator's property.

The following points are to be observed to ensure the appliance safety:

- The appliance may only be operated as intended, when it is in perfect condition with regards to technical standards, with awareness of safety and hazards and in accordance with the operating instructions.
- All the operating and actuating elements must be in a perfect and functionally reliable condition with regards to technical standards.
- The appliance must be checked for external visible damage and defects whenever it is put into operation. In case of damages, immediately inform the competent bodies and switch off the appliance.
- Modifications or retrofits of the equipment are only permitted in consultation with the manufacturer and on receipt of his written agreement.
- The appliances can only be operated under continuous supervision.
- Move the appliance only with the doors closed. Unless the doors are properly closed, they can open during transport and cause damage or lead to injuries.
- Release both total brakes before commencing transporting. Moving the appliance with the total brakes locked can damage the chassis.

- Transport should only be undertaken over level floors. Moving the appliance over very uneven floors and stair steps can damage the chassis.
- Do not stop the appliance by applying the total brakes. The total brakes are designed to be able to prevent the appliance from unintended moving. Do not stop the appliance on sloping floors. Secure the appliance against rolling away by applying both total brakes when stopping it.
- When approaching walls and moving round obstacles always pay attention to persons in the way. Risk of injury.
- When transporting the appliance, hold the push bars with your hands. Never let go of the appliance while moving it.
- When transporting the appliance, do not move it faster than a walking pace. Heavily laden appliances are difficult to brake and steer. If necessary, ask for assistance when transporting the appliance.
- If the appliance tips over due to outside influence or inattention, never catch it manually. Risk of injury.
- In the case of off-site transport in a vehicle such as a lorry, the appliances should be secured properly. The total brakes are not sufficient as a transport securing method.
- Before transporting, switch off the appliance, pull out the mains plug and insert it into the holder provided.
- Never pull the mains plug out of the socket by the connecting lead.
- Never move the appliance by pulling by the connecting lead.
- If the mains plug has come into contact with water it must be dried before inserting it into the socket. Danger to life.
- Damaged mains plugs or the connecting lead are to be replaced by authorised specialists before the appliance is used.
- Do not use any extension leads in wet and damp areas.

## 2.4 Safety Instructions for Transport

---

The following points are to be observed when transporting the appliance:

- When loading, use only hoists and load lifting devices approved for the weight of the appliance to be lifted.
- Use transport vehicles that are approved for the weight of the appliance.
- Do not put a defective appliance into operation in any case and inform the supplier immediately.

## 2.5 Safety Instructions for Cleaning and Care

---

The following points must be observed when carrying out any cleaning and maintenance operations:

- Take the appliance out of operation, switch it off, pull out the mains plug and secure it against unauthorised reactivation before performing cleaning and care measures.
- For reasons of hygiene, the cleaning instructions must be strictly observed.
- Heated appliances must be out of operation and sufficiently cooled before cleaning.
- Do not clean the appliance with steam-jet or high-pressure washers. The appliance must be taken out of operation and switched off at the mains beforehand in any area where steam-jet or high-pressure washers are to be used.

## 2.6 Safety Instructions for Troubleshooting

---

The following points must be observed when carrying out any troubleshooting operations:

- The local applicable Accident Prevention Regulations must be observed.
- Take the appliance out of operation, switch it off, pull out the mains plug and secure it against unauthorised reactivation before performing maintenance or troubleshooting operations. When working on the electrical installation, the appliance must be switched off at the mains and secured against reactivation. This work must only be carried out by an electrician.
- Observe the valid product safety regulations for the product when handling oils, greases and other chemical substances.
- Carry out all the checks and inspections of the appliance on a regular basis. Remedy immediately deficiencies, such as loose screw connections, melted or damaged leads.
- Only authorised specialists may perform all repair work.
- Defective components should only be replaced with original parts.

## 2.7 Notes on Specific Hazards

---

### Electrical energy

- All work on the electrical installations should only be carried out by an electrician or by authorised specialists under supervision and monitoring of a certified electrician according to the applicable electro-technical regulations.
- The appliances on which inspection, maintenance and troubleshooting work is performed must be disconnected from the power supply and secured against reactivation when voltage is not required for this kind of work. This must only be carried out by an electrician.

## 3 Description and Technical Data

---

### 3.1 Performance Description

---

Appliances from the ISOBOX® Mobil model range are intended for the short-distance transport and distribution of food. They carry prepared meals in Gastronorm containers or baskets and on grids.

The appliances are configurable, i.e. their design can be fully adapted to specific requirements and individual needs.

The modular design permits the individual, vertical or horizontal arrangement of the thermally insulated and separated boxes. Due to the insulation, boxes situated above or next to each other are not affected.

Depending on the chosen accessories, heating or cooling modules are magnetically attached to the back of the appliance. These can be flexibly exchanged or combined as needed. The blind cover on the backside also permits the creation of neutral cupboard spaces.

### 3.2 Proper Use

---

The appliances are only intended for keeping food in Gastronorm containers or portioned meals on grids or in baskets hot and/or refrigerated.

The appliances are only intended for transport across short distances. For long-distance transport, the modules of the appliance must be connected to a power outlet and switched on at regular intervals in order to keep the products warm or refrigerated.

When cooling meals or their components, it is necessary to comply with the respective legal directives on food storage (duration and temperature).

Proper use includes observing defined procedures, compliance with the stated specifications and use of supplied or additionally available original accessories.

Any other use of the appliance is considered as unintended use.

### 3.3 Improper Use

---

The following is considered as improper use of the appliance:

- Any change of the performance parameters of the appliance beyond the guaranteed values.
- The operation of the appliance without or by avoiding its safety devices.
- The operation of a defective appliance.
- Improper installation, commissioning, operation or maintenance of the appliance.
- The insertion of objects which severely impede the functioning of the appliance.
- Loading the appliance with other loads than specified.
- The use of the appliance as a room heater or dish dryer.
- Exceeding the maximum transport time of hot meals between two heating phases.
- Transport of persons. In no case may people sit or stand on the appliance.
- Transport of open containers with hot liquids.

Any other use is not permitted and it is considered as improper use. The manufacturer and suppliers are not liable for any consequential damage resulting from unintended use. No liability is assumed and no warranty claims can be submitted for damages caused by improper use.

## 3.4 Appliance Description

### 3.4.1 View of the appliance

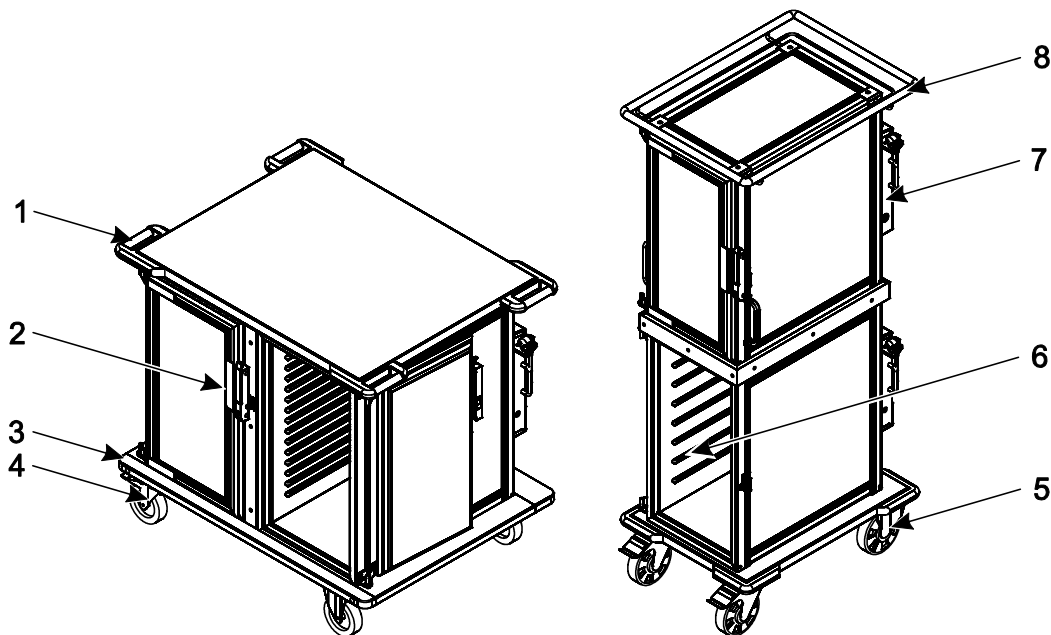

**Figure 1** View of the appliance ISOBOX® Mobil

- |   |                                |   |                                |
|---|--------------------------------|---|--------------------------------|
| 1 | Push bar                       | 5 | Swivel caster with total brake |
| 2 | Door lock                      | 6 | Support rails                  |
| 3 | Corner bumpers                 | 7 | Module                         |
| 4 | Swivel caster with total brake | 8 | Peripheral gallery             |

### 3.4.2 Appliance Description

The appliances of the ISOBOX® Mobil model range can be configured in a wide variety of ways and may be fitted with optional accessories.

The body of the appliance is formed by thermally insulated and separated boxes. The boxes can be arranged individually and in both vertical or horizontal direction.

The doors, back and side panels consist of plastic and their colours can be customised. Available colours include zinc yellow, traffic red, sky blue and traffic grey A. Further colours are available upon request.

Upon request, heating or cooling modules are magnetically attached to the back of the appliance. These can be flexibly exchanged or combined. If several modules are used, they can be connected with each other in such a way that the appliance can be operated with a single power supply. The blind cover on the backside also permits the creation of neutral cupboard spaces. Due to the thermal insulation, cupboard compartments situated above or next to each other are not affected.

The inner housing is equipped with seamless and deep-drawn support rails which are available in two distances. Two large radii and smooth surfaces allow easy cleaning of the interior. The tablets are inserted in longitudinal direction from the front. The hinged doors are pivotable by 270°. Lockable hinged doors are available as an option.

Casters are available in different sizes and designs and ensure optimum movement and manoeuvrability for the appliance.

The vertical version consists of one large box or two boxes on top of each other. Due to the attached push bar, it is possible to easily manoeuvre the appliances even when fully loaded.

In the horizontal version, two boxes are arranged next to each other. Ergonomically shaped push bars with an integrated bumper at each of the narrower sides protect against injuries to the hands and damage to the appliance. Together with the corner bumpers installed at the bottom of the appliance, they provide all-round protection from damage. Push bars and corner bumpers are made of high-quality, impact-resistant plastic.



### 3.4.3 Equipment and optional accessories

The appliances can be configured as required and supplemented with optional accessories:

- Colour of the door and side panels:  
The standard programme includes the following colours: traffic grey (RAL 7042), traffic red (RAL 3020), sky blue (RAL 5015) and zinc yellow (RAL 1018). Special colours are available upon request.
- HGV skirting protection:  
The HGV skirting protection is intended for protecting and securing the appliances whilst being transported by machines.
- Gallery:  
The gallery on the roof of the trolley on the front and rear side ensures that items such as crockery baskets are safely transported. Optionally, the gallery is available in a continuous version (on all four sides) or closed on three sides.
- Casters:  
Made of stainless steel, fixed casters, swivel casters with or without total brake, available in three different sizes.
- Rifix:  
Directional casters with central lock tread Casters fitted with Rifix can be fixed to roll in one direction only. This significantly facilitates the directional stability, e.g., during train operation. Not suitable for casters with Ø 4.9" (125 mm)
- Central total brake:  
Only for horizontal appliances. Not available for vertical appliances due to the narrow track gauge.
- Train operation:  
For train operation, a triangular drawbar or a holdable drawbar can be installed.

The part numbers of the special accessories can be found in the spare parts catalogue and order lists available online.

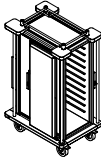
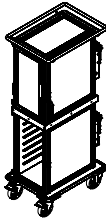
## 3.5 Technical Data

	Dim.	Model 1	Model 2	Model 3
				
Appliances with size 75 support rails		IBM/V 1/16 75	IBM/V 2/16 75	IBM/H 2/16 75
Appliances with size 37.5 support rails		-	IBM/V 2/30 37,5	IBM/H 2/30 37.5
Width	in	22.6	22.6	41.9
	(mm)	575	575	1064
Depth	in	31.5	31.5	31.5
	(mm)	799	799	799
Height (with size 125 caster)	in	61.5	68.4	38
	(mm)	1561	1737	965
Height (with size 160 caster)	in	63	70	40
	(mm)	1601	1777	1005
Height (with size 200 caster)	in	-	-	41.1
	(mm)	-	-	1045
Height with gallery	in	-	-	+ 2
	(mm)	-	-	+ 52

	Dim.	Model 1	Model 2	Model 3
Corner bumper distance (front)	in	1.8	1.8	1.8
	(mm)	45	45	45
Own weight	lbs	220.5	253.5	286.6
	(kg)	100	115	130
Payload	lbs	220.5	220.5	220.5
	(kg)	100	100	100
Corner bumper distance (back)	in	3.7	3.7	3.7
	(mm)	94	94	94
No. of (size 75) support rails, arrangement of boxes		16	2x8 up and down	2x8 left and right
No. of (size 37.5) support rails, arrangement of boxes		-	2x15 up and down	2x15 left and right
Tray insertion		lengthwise	lengthwise	lengthwise
tray stop unit		Conductor profiles	Wire Ø 0.4" (10mm)	Wire Ø 0.4" (10mm)
Neutral module/ back panel module		available as an option	available as an option	available as an option
Heating module		230V / 800W	230V / 400W	230V / 400W
Connection / Voltage / Power				
Digital control	°F (°C)	140 (90)	140 (90)	140 (90)
Refrigeration module (Peltier element)		-	230V / 150W	230V / 150W
Connection / Voltage / Power				
Digital control	°F (°C)	-	39.2 (4)	39.2 (4)
Protection class per module		IP 32	IP 32	IP 32

The corresponding test marks can be found on our home page at [www.hupfer.de](http://www.hupfer.de).

### 3.6 Rating Plate

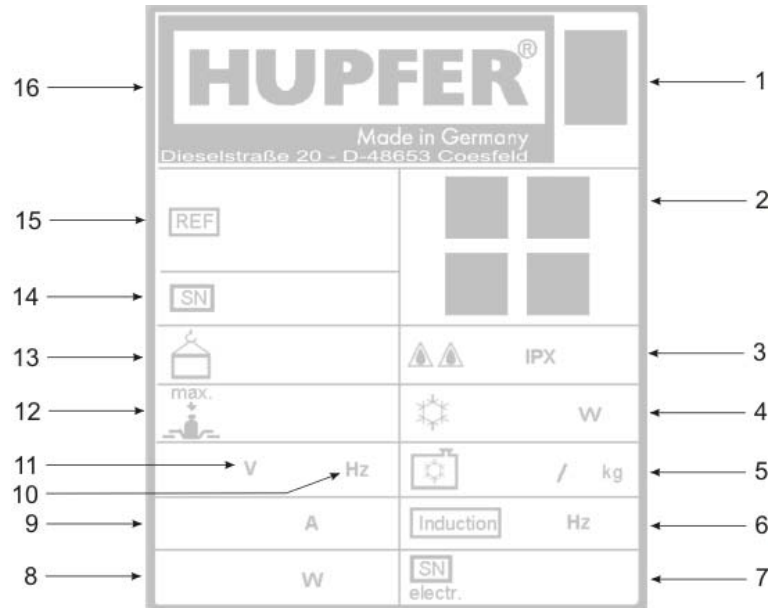

**Figure 2** Rating plate

1	Disposal of old appliances	9	Nominal current
2	Test mark	10	Frequency
3	Protection class	11	Nominal voltage
4	Chilling capacity	12	Payload
5	Refrigerant	13	Own weight
6	Induction frequency	14	Serial number/Order number
7	Current serial number	15	Item and brief description
8	Electric power	16	Manufacturer



## 4 Transport, Putting into Operation and Decommissioning

### 4.1 Transport

#### ATTENTION

#### Appliance damages caused by improper transport



In the case of off-site transport in a vehicle such as a lorry, the appliances should be secured properly. The total brakes are not sufficient as a transport securing method.

If the appliances are not secured properly, there is a risk of damage to property and persons caused by squashing.

During transport, secure all the individually standing appliances using corresponding transport securing devices.

The appliance is delivered as an assembled unit, i.e. it is completely assembled including the heating and/or refrigeration modules.

When loading, use only hoists and load lifting devices approved for the weight of the appliance. Transport vehicles which are approved for the weight of the appliance may also be used.

The scope of delivery is specified in the shipping documents in accordance with the valid purchase agreement and included with the delivery item.

### 4.2 Putting into Operation

#### DANGER

#### Hazardous electrical voltage



The electrical voltage may be considerably dangerous to limb and life of persons and lead to injuries.

Before putting the appliance into operation check, whether the power supply indicated on the rating plate (230V / 50 Hz) corresponds to the local power supply. Otherwise, do not put the appliance into operation.

Do not use any extension leads in wet areas.

Remove the original packing and check, whether the appliance is complete and undamaged. In no case put a defective appliance into operation and inform the supplier immediately.

Always place the appliance on firm and level floors when unpacking and operating it. Apply the total brakes on both swivel casters to secure the appliance against rolling away.

#### INFO

#### Disposal of packing material

The packing consists of recyclable materials and can be disposed of appropriately. Thereby, the different materials are to be separated and disposed in an environmentally compatible manner. In any case, the local bodies responsible for disposal are to be involved for this purpose

The appliance should be thoroughly cleaned with a soft cloth before putting it into operation for the first time. Ensure the appliance is clean and dry before it is put into operation.

The following appliance functions must be checked before putting it into operation:

- the functioning of the total brakes
- the functioning of the operating elements and the heating and/or refrigeration modules.

## 4.3 Storage and Recycling

---

Temporary storage must take place in a dry and frost-free environment. The appliance must be kept covered with a suitable covering material to be protected against dust ingress.

The appliance kept in the storage location must be checked for damages and corrosion every 6 months.

<b>NOTE</b>	<b>Condensed water formation</b>
Ensure that there is sufficient ventilation and no large temperature fluctuations in the storage location to avoid condensed water formation.	

Before the appliance is taken back into operation it must be clean and dry.

If the appliance is required to be recycled, all the operating and auxiliary materials must be disposed of in an environmentally compatible manner. The recyclable materials must be properly separated and disposed of in an environmentally compatible manner according to the local Waste Disposal Regulations. In any case, the local bodies responsible for disposal are to be involved for this purpose. Separate the reusable materials of the appliance (casters and plastic parts) before disposing or send the appliance to a recycling centre. Dispose the electronics at corresponding collection centres.

We offer our customers to dispose their waste appliances. Please contact us or one of our distribution partners.

Packaging and packing material can be sent to the recycling centre by indicating the waste disposal contract number. If you do not have the valid waste disposal contract number, you can ask for it at [HUPFER®](#) - Service.

## 5 Operation

### WARNING

### Risk of hot surfaces



If the thermostat is set to the level 3 (approx. 149°F or 90°C) and higher, the permitted maximum temperature of 149°F (65°C) for touchable appliance surfaces can be exceeded. Direct contact with your skin can cause burns.

Only instructed staff may operate the appliance. Wear suitable protective clothing.

The appliance must be checked for external visible damages and defects before each operation. Before putting the appliance into operation, the cupboard compartments of the appliance must be clean.

### 5.1 Arrangement and Function of the Operating Elements

The operating elements are arranged on the backside of the appliance at the top of the corresponding module.

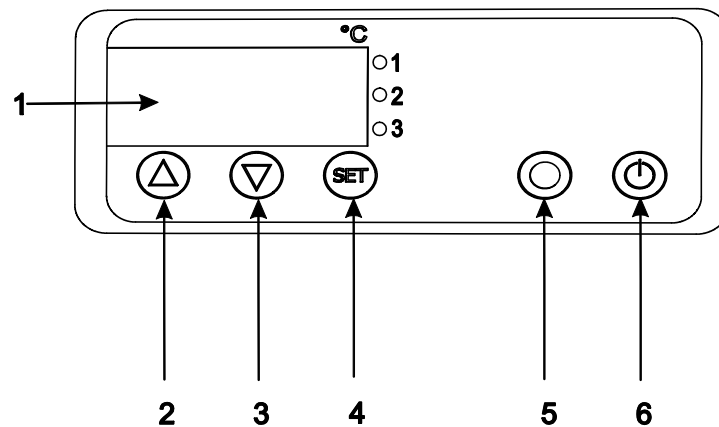

**Figure 3** Operating elements

Position digit	Operating element	Function
1	Display	Shows the values or parameters
2	UP button	Increases parameters or parameter values when pressed
3	DOWN button	Decreases parameters or parameter values when pressed
4	SET key	Shows the target value S1 while this button is pressed; is also needed for setting parameters
5	Selection button A	Adopts various functions for parameterisation; this button must be pressed for at least half a second.
6	On/off key	Switches the module on; pressing it again switches the module off

## 5.2 Operation

### DANGER



#### Hazardous electrical voltage

The electrical voltage may be considerably dangerous to limb and life of persons and lead to injuries.

Only use the plug connection provided for this. The appliance should not be operated with a damaged connecting line or other visible damages.

All work on the electrical installations should only be carried out by an electrician or by authorised specialists under supervision and monitoring of a certified electrician according to the applicable electro-technical regulations.

### WARNING



#### Risk of hot surfaces

If the thermostat is set to the level 3 (approx. 90°C) and higher, the permitted maximum temperature of 149°F (65°C) for touchable appliance surfaces can be exceeded. Direct contact with your skin can cause burns.

Only instructed staff may operate the appliance. Wear suitable protective clothing.

### WARNING



#### Risk of hot surfaces

Metal parts of the appliance can get very hot during operation. Water steam escaping from Gastronorm containers can cause scalds.

Take care when opening and closing the door. Wear protective gloves.

### Setting the temperature

#### NOTE

#### Refrigeration module

The required temperature of the appliance has been set to 41°F (5°C) by factory default. The temperature with the door closed will be reached after 1.5 hours.

#### NOTE

#### Heating module

The required temperature of the heating module has been set to 194°F (90°C) by factory default. The temperature with the door closed will be reached after 1.5 hours.

- Attach the modules to the cupboard compartments.
- Close the cupboard compartments.
- Connect the module(s) to the mains.
- Switch module(s) on using the On/off key.

## Moving

### ATTENTION

#### Injuries and damage to property due to improper transport



The appliances may only be moved when the doors are closed. Unless the doors are closed, they can open during transport and cause damages or lead to injuries.

Before transport, check whether the doors of the appliance are safely closed.

- Switch module(s) off using the On/off key.
- Pull out the mains plug and insert it into the plug park provided.
- Release the total brakes.
- Move the appliance the destination by the push bars to.
- Upon arrival at the destination, apply both total brakes and make sure they are locked and the appliance is secured against unintended movement.
- Connect the appliance to the mains.
- Switch module(s) on using the On/off key.

## 5.3 Measures at the End of Operation

### WARNING

#### Risk of hot surfaces





Heated Gastronorm containers can be very hot after operation and exceed the maximum temperature of 65°C, at which you are allowed to touch the appliance surfaces with bare hands. Direct contact with unprotected skin can cause burns.

Act carefully. Wear suitable protective gloves.

- Switch module(s) off using the On/off key.
- Apply both total brakes, make sure they are locked and the appliance is secured against unintended movement.
- Pull out the mains plug and insert it into the plug park provided.
- Remove inserted containers, trays or grids.
- Leave doors open in order for the appliance to cool down or warm up.

## 6 Troubleshooting and Repair

### 6.1 Safety Measures

<b>DANGER</b>	<b>Hazardous electrical voltage</b>
	<p>The electrical voltage may be considerably dangerous to limb and life of persons and lead to injuries.</p> <p>Before looking for faults, switch off the appliance at the mains. Switch off the appliance. Pull out the mains plug and hung it on the plug holder provided.</p>
<b>WARNING</b>	<b>Risk of hot surfaces</b>
	<p>The heated appliances can become hot during operation and only cool down slowly in the air.</p> <p>Before looking for faults, let the appliance cool down sufficiently.</p>

### 6.2 Notes on Troubleshooting

Please contact our service partners in case of malfunction and complaints within the warranty period. Even after the warranty period is expired you can have necessary repair work done by our service partners and certified electricians.

Service work should only be carried out by authorised specialists.

Defective components should only be replaced with **HUPFER®** original parts. The modular design simplifies the replacement of individual components.

Always specify the data and corresponding part number indicated on the rating plate when using the after-sales service or ordering spare parts.

Regular inspection and maintenance of the appliance prevent disruptions to operation and ensure safety.

### 6.3 Fault and Action Table

Fault	Possible cause	Action
Running noise of swivel casters	Defective caster bearings	Replace the swivel casters.
	Sticky surface of the casters	Clean the swivel casters.
The appliance pulls to the right or to the left when transporting	Damaged caster bearings	Replace defective casters with new ones
Rolling resistance of the casters is higher than when putting the appliance into operation	Damaged caster bearings	Replace defective casters with new ones
Total brakes do not have any locking action	Wear of the locking brakes	Replace the locking brakes or replace defective casters with new ones
Appliance does not become warm	Defective building fuses	Check fuse and repair, if necessary
	Defective control system	Switch off the appliance at the mains, have it checked and repaired by authorised specialist staff, if necessary
	Defective mains connecting lead or mains plug	Switch off the appliance at the mains, have it checked and repaired by authorised specialist staff, if necessary

Fault	Possible cause	Action
The appliance takes too long to heat up	Door not closed properly	Close door
	Damaged lip seal	Replace the seal (see the list of spare parts)
Appliance does not become cold	Defective building fuses	Check fuse and repair, if necessary
	Defective control system	Switch off the appliance at the mains, have it checked and repaired by authorised specialist staff, if necessary
	Defective mains connecting lead or mains plug	Switch off the appliance at the mains, have it checked and repaired by authorised specialist staff, if necessary
The appliance takes too long to cool down	Door not closed properly	Close door
	Damaged lip seal	Replace the seal (see the list of spare parts)

## 7 Cleaning and Care

---

### 7.1 Safety Measures

---

#### DANGER

#### Hazardous electrical voltage



The electrical voltage may be considerably dangerous to limb and life of persons and lead to injuries.

Before cleaning, switch off the appliance at the mains. Switch off the appliance. Pull out the mains plug and insert it into the plug holder provided.

---

#### WARNING

#### Risk of hot surfaces



The heated appliances can become hot during operation and only cool down slowly in the air.

Before cleaning, let the appliance cool down sufficiently.

---

#### ATTENTION

#### Do not clean with running water



The appliance should not be cleaned with running water, steam-jet or high-pressure washers.

The appliance must be taken out of operation and switched off at the mains beforehand in any area where steam-jet or high-pressure washers are to be used.

---

### 7.2 Hygiene Measures

---

The correct behaviour of the operating staff is decisive for optimal hygiene.

All persons must be informed about the locally valid hygiene regulations, observe them and comply with them.

Stick a waterproof plaster to cover wounds on the hands and arms.

Never sneeze or cough on clean crockery or meals.

### 7.3 Cleaning and Care

---

#### NOTE

#### Starting the cleaning process

After operating an appliance with a refrigeration module, do not start cleaning until the temperature of the internal surfaces of the appliance is the same as the ambient temperature. Otherwise the moisture from the ambient air can condense on the cold walls of the appliance and slow down the drying process.

---

If the appliance is handled with care, cleaned and maintained on a regular basis, it does not require any additional care measures. The boxes should be cleaned regularly after every use to ensure a perfectly hygienic operation.

For quick and thorough cleaning, wipe the inside of the boxes with a soft cloth. Use for cleaning a soft cleaning cloth or an uncoated sponge. Use degreasing liquid cleansers that are approved for food industry. Never use high-pressure cleaners, chloride-containing cleaning agents, abrasive cleaning powder or other dry cleaning agents, steel wool, steel sponges and/or sharp-edged items.



## 7.4 Special Care Instructions

---

The resistance to corrosion of stainless steels is based on a passive layer which is formed on the surface when oxygen is admitted. The oxygen in the air is sufficient for the formation of the passive layer, so that faults or damage to the passive layer can be remedied again automatically by mechanical action.

The passive layer develops or reforms more quickly when the steel comes into contact with flowing water containing oxygen. The passive layer can be chemically damaged or disrupted by agents having a reducing (oxygen-consuming) action when the steel comes into contact with them in concentrated form or at high temperatures.

Such aggressive substances are for example:

- substances containing salt and sulphur
- chlorides (salts)
- seasoning concentrates (e.g. mustard, vinegar essence, seasoning cubes, saline solutions).

Further damages can occur due to:

- extraneous rust (e.g. from other components, tools or rust film)
- iron particles (e.g. grinding dust)
- contact with non-ferrous metals (element formation)
- lack of oxygen (e.g. no admission of air, low-oxygen water).

General working principles for the handling of appliances made of "refined stainless steel":

- Always keep the surface of appliances made from stainless steel clean and accessible to the air.
- Use cleaning agents suitable for stainless steel. No bleaching and chloride-containing cleaning agents should be used.
- Remove layers of lime scale, grease, starch and egg-white daily by cleaning. Corrosion can occur underneath these layers due to lack of air admission.
- After each cleaning operation remove all cleaning agent residues by wiping thoroughly. Afterwards, the surface should be thoroughly dried.
- Do not bring parts made of stainless steel into contact with substances such as concentrated acids, seasonings and salts for longer than is absolutely necessary. Acid fumes which generate during cleaning of tiles also promote the corrosion of "refined stainless steel".
- Avoid damaging the surface of the stainless steel, particularly by metals other than stainless steel.
- Residues of extraneous metals produce extremely small amounts of chemical elements which can cause corrosion. In any case, contact with iron and steel should be avoided because that leads to extraneous rust. If stainless steel comes into contact with iron (steel wool, steel particles from pipes, water containing iron), this can be a trigger for corrosion. Therefore, for mechanical cleaning use exclusively refined steel wool or brushes with natural, plastics or refined steel bristles. Steel wool or brushes with unalloyed steel lead to extraneous rust due to abrasion.

## 8 Spare Parts and Accessories

---

Service work should only be carried out by authorised specialists.

Defective components should only be replaced with **HUPFER®** original parts or identical spare parts. That is the only way to guarantee a safe operation. We must inform you that a perfect functionality of the appliance can only be ensured if you use recommended original parts by **HUPFER®**. No or only conditionally suitable spare parts may jeopardise the warranty.

Spare parts and accessories can be ordered at **HUPFER®** Service (Tel. +49 2541 805-0). When ordering spare parts or in the event of after-sales service always specify the order number and specifications on the rating plate.