



# operator manual

---

## *Impinger® Conveyor Oven* *Series 1400*

This document includes:

- Safety Notices
- Specifications
- Installation Instructions
- Operating Instructions
- Cleaning Instructions
- Warranty Statement











Revision: G  
P/N: 2810197



Lincoln Foodservice Products, LLC  
1111 North Hadley Road  
Fort Wayne, Indiana 46804  
United States of America  
Technical Support Hotline: (800) 678-9511  
Telephone: (260) 459-8200  
[www.lincolnfp.com](http://www.lincolnfp.com)

## IMPORTANT WARNING AND SAFETY INFORMATION

	<b>NOTE:</b>	This manual contains important safety and installation-operation instructions. Require all operators to read this manual thoroughly before installing, operating or servicing this equipment. Improper installation, adjustment, alteration, service or maintenance can cause property damage, injury or death.
	<b>WARNING:</b>	This appliance is not intended for use by young children or infirm persons unless they have been adequately supervised by a responsible person to ensure that they can use the appliance safely. Young children should be supervised to ensure that they do not play with the appliance.
	<b>WARNING:</b>	Improper installation, adjustment, alteration, service or maintenance can cause property damage, injury or death. Read the installation, operating and maintenance instructions thoroughly before installing or servicing this equipment.
	<b>DANGER!</b>	Do not work around conveyor belt with long hair, loose clothing, or dangling jewelry. Getting caught in the belt could result in serious injury.
	<b>DANGER!</b>	For your safety, do not store or use gasoline or other flammable vapors or liquids in the vicinity of this or any other appliance.
	<b>DANGER!</b>	Do not spray aerosols in the vicinity of this appliance while it is in operation.
	<b>DANGER!</b>	If the power supply cord appears to be damaged, do not attempt to operate the unit. Contact a service agent or qualified electrician to repair!
	<b>DANGER!</b>	Do not use parchment paper when placing food product through the toaster! Use of such materials may cause a fire and should never be placed in the toaster.

- Obtain from your local gas provider and post in a prominent location instructions to be followed in the event gas odors are detected.
- It is required that the oven be placed under a ventilation hood to provide for adequate air supply and ventilation.
- Minimum clearances must be maintained from all walls and combustible materials. See “spacing requirements” section for more information.
- Keep the oven free and clear of combustible material.
- Adequate clearance for air openings to the combustion control chamber on the right side of the oven is required.
- Do not obstruct the ventilation holes in the control panels, as these provide the combustion air for the burner and cooling air for the controls.
- The oven is to be operated only on the type of gas and/or electricity as shown on the specification plate.
- The power burner will not operate and gas will not flow through the burner without electrical power.
- This manual should be retained for future reference.
- The electrical wiring diagram is located under the control box covers.

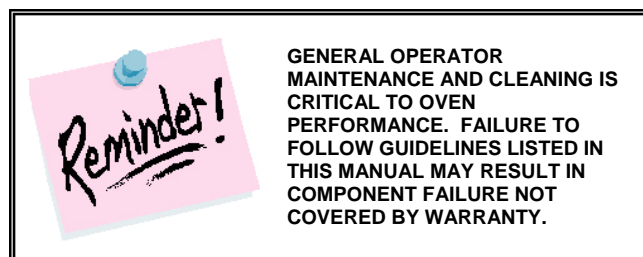

## PURCHASER’S RESPONSIBILITY

It is the responsibility of the purchaser:

1. To see that the gas and electric services for the oven are installed on site in accordance with the manufacturers specification.
2. To unload, uncrate, and install the oven in its proper location; in accordance with this installation / operation manual.
3. To see that the gas and electric services are connected properly by a qualified installer of your choice. *For installation in the State of Massachusetts: Installation of this oven must be performed by a licensed plumber or gas fitter.* All such connections must be in accordance with applicable code requirements. See “Code Reference” section for specific code references.
4. To arrange for inspection and operation check-out by an Authorized Service Technician as described below:

Do not attempt to operate the oven until connection of utility service has been fully inspected by an Authorized Service Technician or a Lincoln Foodservice Products Service Representative. This service is required by Lincoln Foodservice Products, LLC in order to assist the purchaser in proper start-up of the oven on site. Please note the specific details on the Warranty and make certain connections are made to proper utility services.

The warranty shall not apply if the oven(s) are started up and operated prior to the utilities and oven being inspected and check out made by an Authorized Service Technician or a Lincoln Foodservice Products Service Representative.

## TABLE OF CONTENTS

WARNING AND SAFETY INFORMATION.....	2
PURCHASER’S RESPONSIBILITY.....	3
MODEL NUMBER KEY.....	4
UTILITY SPECIFICATIONS.....	5
EXTERIOR DIMENSIONS.....	6
GENERAL INFORMATION.....	7
UNLOADING & UNCRATING.....	7
STAND & FINGER ASSEMBLY.....	8
SPACING REQUIREMENTS.....	10
VENTILATION.....	10
MANUAL GAS VALVE INSTALLATION.....	12
CODE REFERENCES.....	12
RESTRAINT REQUIREMENTS.....	13
PROGRAMMING.....	13
FUNCTIONS.....	14
FINGER & CONVEYOR REMOVAL / REINSTALLATION.....	15
OPERATOR MAINTENANCE.....	16
CLEANING INSTRUCTIONS.....	16
PREVENTIVE MAINTENANCE.....	17
STACKING WITH OTHER OVENS.....	17
HOW TO OBTAIN SERVICE.....	17
APPENDIX A – LABEL DEFINITIONS.....	18
WARRANTY STATEMENT.....	20

## MODEL NUMBER KEY

EXAMPLE: 1433-B00-E-K1801

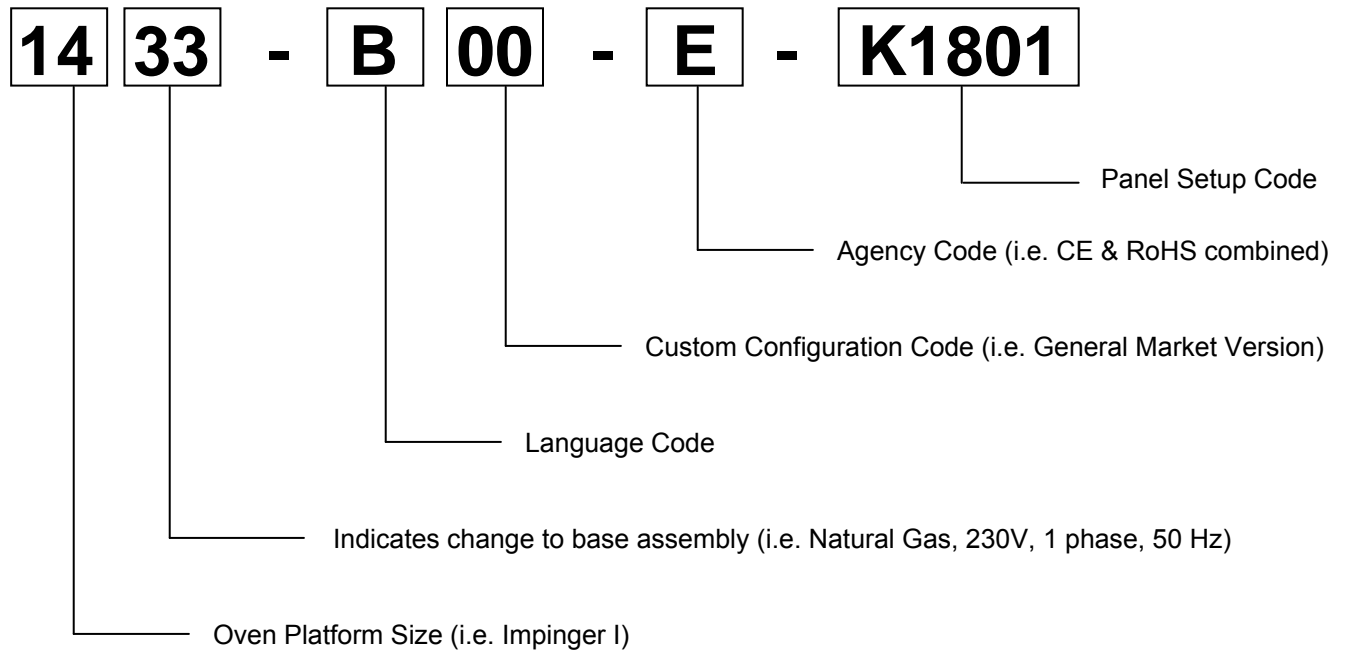

CODE	LANGUAGE	COUNTRY	CODE	LANGUAGE	COUNTRY
0	English	Dom. & Int. Default	N	Finnish	Finland
B	French	France/Luxembourg	O	Restricted	---
C	German	Germany	P	Norwegian	Norway
D	Italian	Italy	Q	English	Japan
E	Spanish	Spain	R	Swedish	Sweden
F	English	UK/India/Africa/Hungary	S	English	Australia
G	Spanish	Mexico/Latin America	T	Mandarin	China
H	Portuguese	Portugal	U	Restricted	---
I	Not Used	---	V	English	Pacific Rim/Korea
J	Danish	Denmark	W	English	Middle East
K	Dutch & French	Belgium	X	Not Used	---
L	Dutch	Netherlands	Y	Not Used	---
M	Greek	Greece	Z	Not Used	---

### AGENCY CODE TABLE

CODE	AGENCY
N	No Agency
E	CE & RoHS compliance combined
U	US & Canada compliance only
A	Advantage style oven to be phased-out
B	Australia AGA

## UTILITY SPECIFICATIONS REQUIRED – ELECTRIC

Model	Energy	Power	Voltage	Current	Phase	Hz	Recommended Electrical Specifications
*1421-xxx-E-Kxxx	Electric	27 kW	400/230V	40 Amps	3	50 Hz	5 Wires, 3 Poles 1N-1G
*1452-xxx-E-Kxxx	Electric	27 kW	120/208V	80 Amps	3	60 Hz	5 Wires, 3 Poles 1N-1G
*1453-xxx-E-Kxxx	Electric	27 kW	120/240V	70 Amps	3	60 Hz	5 Wires, 3 Poles 1N-1G
*1454-xxx-E-Kxxx	Electric	27 kW	380Y/220	41 Amps	3	50 Hz	5 Wires, 3 Poles 1N-1G
*1455-xxx-E-Kxxx	Electric	27 kW	415Y/240	38 Amps	3	50 Hz	5 Wires, 3 Poles 1N-1G
*1458-xxx-E-Kxxx	Electric	27 kW	400	38 Amps	3	50 Hz	5 Wires, 3 Poles 1N-1G

## UTILITY SPECIFICATIONS REQUIRED – GAS

Model	Energy	Power	Voltage	Current	Phase	Hz	Recommended Electrical Specification	Gas
*1433-xxx-E-Kxxx	Nat. Gas	H <sub>s</sub> 40 kW	230 VAC	3 Amps	1	50 Hz	3 Wires, 1 Pole 1N-1G	H <sub>s</sub> 40 kW/hr at 17.4 mB H <sub>2</sub> O column***
*1434-xxx-E-Kxxx	L.P. Gas	H <sub>s</sub> 40 kW	230 VAC	3 Amps	1	50 Hz	3 Wires, 1 Pole 1N-1G	H <sub>s</sub> 40 kW/hr at 27.4 mB H <sub>2</sub> O column***
*1440-xxx-E-Kxxx	Nat. Gas	35 kW	120 VAC	3 Amps	1	60 Hz	3 Wires, 1 Pole 1N-1G	35 kW/hr at 27.4 mB H <sub>2</sub> O column***
*1441-xxx-E-Kxxx	L.P. Gas	35 kW	120 VAC	3 Amps	1	60 Hz	3 Wires, 1 Pole 1N-1G	35 kW/hr at 27.4 mB H <sub>2</sub> O column***
*1450-xxx-E-Kxxx	Nat. Gas	120,000 BTU	120 VAC	5 Amps	1	60 Hz	3 Wires, 1 Pole 1N-1G	120,000 BTU at 7 inches H <sub>2</sub> O column***
*1451-xxx-E-Kxxx	L.P. Gas	120,000 BTU	120 VAC	5 Amps	1	60 Hz	3 Wires, 1 Pole 1N-1G	120,000 BTU at 11 inches H <sub>2</sub> O column***
*1456-xxx-E-Kxxx	Nat. Gas	120,000 BTU	220/240 VAC	5 Amps	1	50 Hz	3 Wires, 1 Pole 1N-1G	120,000 BTU at 7 inches H <sub>2</sub> O column***
*1457-xxx-E-Kxxx	L.P. Gas	120,000 BTU	220/240 VAC	5 Amps	1	50 Hz	3 Wires, 1 Pole 1N-1G	120,000 BTU at 11 inches H <sub>2</sub> O column***
*1474-xxx-E-Kxxx	Nat. Gas	35 kW	220 VAC	3 Amps	1	50 Hz	3 Wires, 1 Pole 1N-1G	35 kW/hr at 27.4 mB H <sub>2</sub> O column***

\* Reference Model Key

### Electrical Supply for Australia:

**Single Phase:** 240VAC, 50Hz / 20 Amp: one neutral & one earth/ground.

**Three Phase:** 240/415 VAC / 20 Amp; three active, one neutral & one earth/ground.

\*\* In Australia, use a 10 Amp General Purpose Outlet

All ovens require separate service and dedicated neutral.

GAS PRESSURE CONVERSION CHART			
Inches of Water Column	KPa	m-Bar	Millimeters of Water Column
3.5	0.87	8.70	88.9
4.5	1.12	11.2	114.3
7	1.74	17.40	177.8
10	2.48	24.87	254.0
10.5	2.61	26.11	266.7
11	2.73	27.36	279.4
14	3.48	34.81	355.6
14.5	3.61	36.05	368.3

\*\*\*NOTE: For proper operation, the gas valve requires a nominal inlet pressure of 7 inches H<sub>2</sub>O column for natural gas and 11 inches of H<sub>2</sub>O column for L.P. gas. A minimum inlet pressure of 1.0 inch of H<sub>2</sub>O above the manifold setting (NAT. manifold 3.5" H<sub>2</sub>O, L.P. manifold 10" H<sub>2</sub>O) must be maintained with no pressure drop from the no load to full load condition. The maximum inlet pressure must be maintained at or below ½ PSIG (14.5 inches H<sub>2</sub>O column). Refer to the chart on the left for pressure conversions.

# EXTERIOR DIMENSIONS

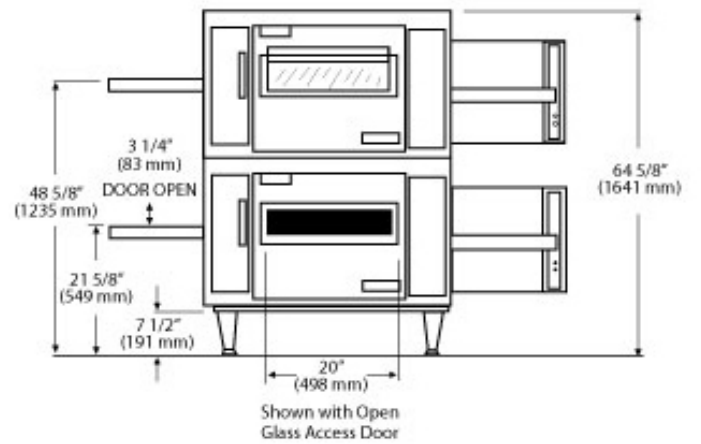
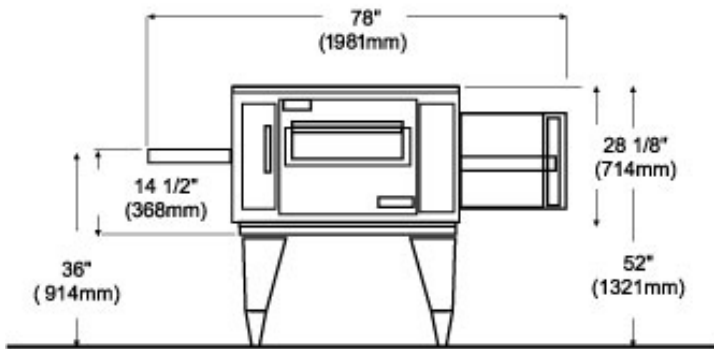
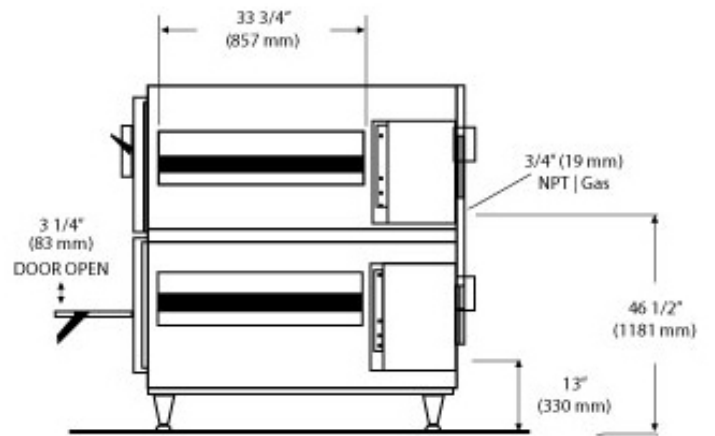
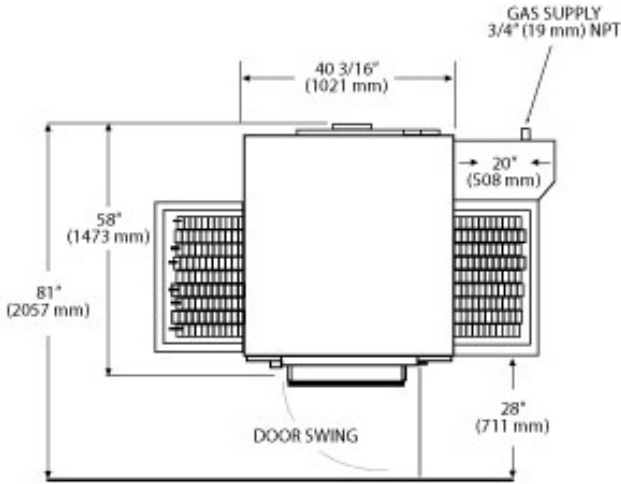

## GENERAL INFORMATION

The instructions that follow are intended as a guide for preparing for the installation of the Impinger Conveyor Oven.

First and foremost, each crate should be examined before signing the Bill of Lading to report any visible damage by the trucker in transit, and to account for the proper number of crates.

The Impinger® oven functions by directing high velocity streams of heated air directly on the food products. Because air is the heat source, it is effective even on sensitive foods. Compared to conventional ovens and even convection ovens, the cooking time of products in the Impinger® Conveyor ovens can be as much as two (2) to four (4) times faster. Several factors may affect the cooking time of any special product such as: 1) oven temperature setting, 2) conveyor speed, 3) position of columnating plate in oven, and 4) adjustments of the 2 baffles on the conveyor openings.

We encourage you to experiment with the oven by trying different temperature settings and belt speeds. Also, try to control the cooking of the product by re-arranging the optional columnating plates.

## IF THERE IS APPARENT DAMAGE:

UNITED STATES AND CANADA: Arrangements should be made to file a claim against the carrier. As Interstate Commerce Regulations require that the claim must be initiated by the consignee.

ALL SHIPMENTS TO OTHER COUNTRIES: Freight terms will be developed and extended on an individual basis.

Proper and secure storage facilities should be arranged for the oven(s) if necessary to protect it from outdoor or damp conditions at all times before installation.

## UNLOADING

When the oven arrives it should consist of:

1. A crate containing oven body, conveyor, fingers, crumb pans, and pan stops. (Some models may have the conveyor packed separately.)
2. A package containing the stand and top.

It is recommended that you have a material-handling device available to unload.

**NOTE: DO NOT LIFT EXCESSIVE WEIGHT!**

## UNCRATING

When you have all the crates unloaded, open the crates and remove the plastic covers. Inspect at once for concealed damage. If anything appears to be damaged, contact the appropriate persons immediately to file a damage claim. After completing this inspection, finish unpacking the oven and all other components. **Be sure to remove the cardboard from the plenum shroud.** Move all components inside near the area where they will be assembled in the order in which they will be assembled.

THE OVEN WILL CLEAR THROUGH A 30" (762 mm) DOORWAY BY USING THE FOLLOWING PROCEDURE:

- A. Remove conveyor; see "Conveyor Removal" section for instructions. (Some units may have conveyor packed separately.)
- B. Remove thumb screws and baffle from the left side of the oven.
- C. Place the left side on a four wheel moving dolly and it will clear a 30" (762 mm) doorway.

## STAND AND FINGER ASSEMBLY

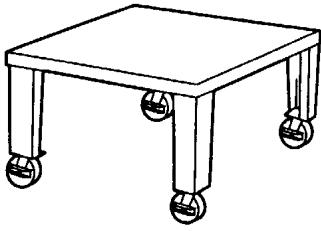

1. The stand is a 40" (1016 mm) x 49" (1245 mm) rectangle. Set it in place with a 40" side facing out. This will be the front of the oven. Using a carpenter's level, level all four (4) sides of the stand. To raise or lower the stand use the leg adjusters. Ovens on casters require a level floor. NOTE: The oven top is packed with oven stand. Remove top from stand before assembly.

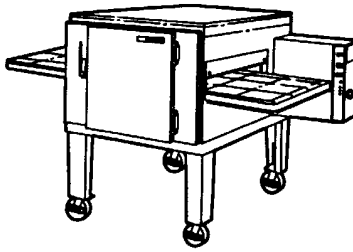

2. Remove the oven from the dolly and set it on the stand. The control panel should be on the right rear as you face the oven. Be sure that the oven sets squarely on the stand and is fully seated. For a single oven, install top. For double, see step 3.



3. If you purchased a double stack oven, place the second oven on top of the first one. Be sure that it sets on squarely and is fully seated. The control panel goes on the right rear. Now install oven top.

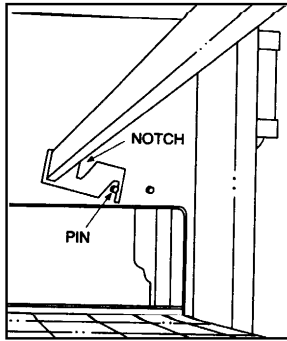

4. Before installing the retaining brackets in the oven(s), be sure all of the packing material is removed from the plenum shroud. Install the finger retaining brackets by placing them upside down and hooking the retaining pin as shown above.

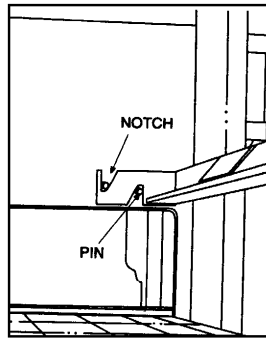

5. Rotate the finger brackets until the notches in the brackets sit on the retaining pins.

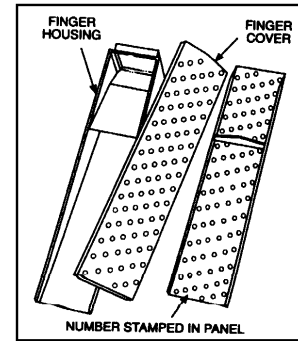

6. Assemble fingers as shown in steps 7 and 8.

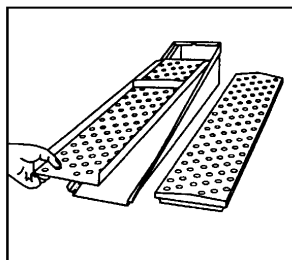

7. Insert columnating plate so the step goes under the lip of the finger housing and the plate lies flush with the housing side edge.

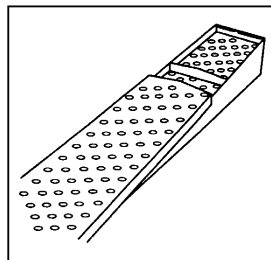

8. Install cover by sliding it on the small end.

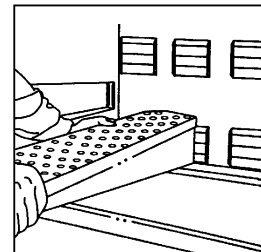

9. Insert assembled finger through door opening starting with lower left. NOTE: The customer MUST tell you what position to place the assembled finger in, for their application.



## STAND AND FINGER ASSEMBLY (CONT'D)

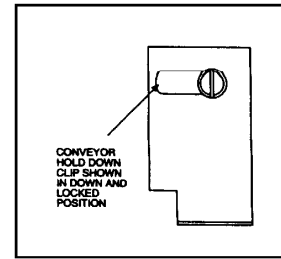
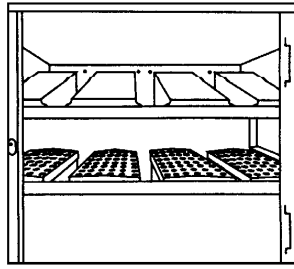
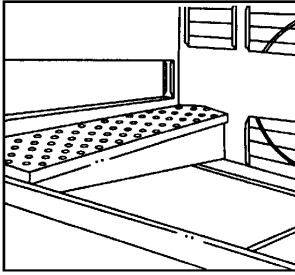

10. Install finger in the oven by sliding it over the plenum flange and setting the front bracket. **BE SURE THAT THE FINGER SETS SQUARELY OVER THE PLENUM FLANGES AND THE HOLES POINT IN THE PROPER DIRECTION.** Top fingers point down, bottom fingers point up.

11. Repeat step 10 until all eight (8) fingers are installed.

Install conveyor and crumb pans before operation. See "Conveyor Installation" section for additional instructions.

**NOTE:** Prior to inserting into the oven opening, slide the conveyor hold-down clips so the screw head is in the left side slot, then rotate counter clockwise to the up position.

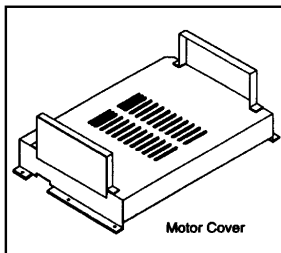

12. Attach Motor Cover as shown with bolts provided.

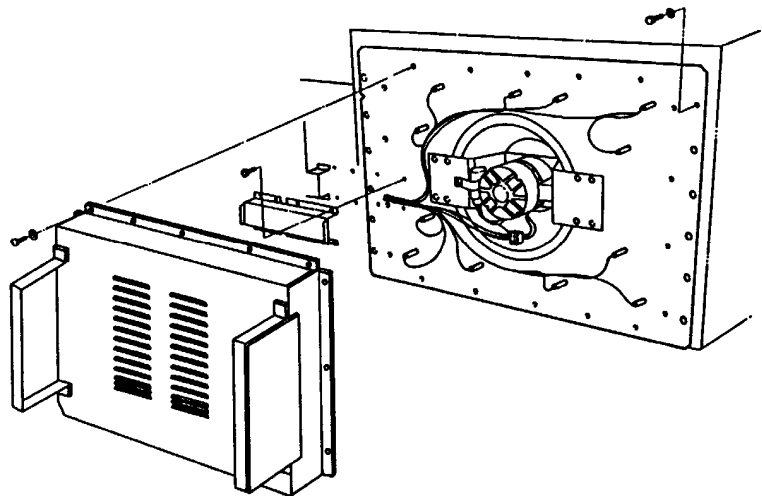

## SPACING REQUIREMENTS

The oven must have 5 inches (127 mm) of clearance from combustible surfaces. In case other equipment is located on the right side of oven, a minimum clearance of 24 inches (609 mm) is required from that equipment.

FOR ALL OVENS: A 24-inch (609 mm) clearance at the rear of the oven must be obtainable for service access.  
FOR PERMANENTLY INSTALLED OVENS: A permanently installed (unmovable) oven requires a minimum of 11 feet clearance on the right hand side to allow for conveyor removal, cleaning, and servicing.

**NOTE: Do not install this (these) oven(s) in any area with an ambient temperature in excess of 95° F / 35° C. Doing so will cause damage to the unit.**



**CAUTION:** Oven must be operated on approved basis only.

## VENTILATION

A VENT IS REQUIRED: Local codes prevail. These are the “authority having jurisdiction” as stated by the NATIONAL FIRE PROTECTION ASSOCIATION, INC. in NFPA 96 latest edition. In addition, to be in compliance with the NFPA 54 Section 10.3.5.2, this unit must be installed with a ventilation hood interlock that prevents the unit from operating when the ventilation hood is off. For further ventilation information, see below.

## VENTILATION GUIDELINES

A ventilation hood is required to remove heat and cooking odors. For gas ovens, a ventilation hood is also required to remove the products of combustion. The hood and HVAC installation must meet local codes to gain approval by the authority having jurisdiction. Requirements may vary throughout the country depending on the location by city, county, and state. Obtain information from the authority having jurisdiction to determine the requirements for your installation. Obtain information and review copies of codes or documents that will be used to inspect and approve your installation. Your ventilation hood supplier and HVAC contractor should be contacted to provide guidance. A properly engineered and installed ventilation hood and HVAC system will expedite approval and reduce oven maintenance costs. Proper ventilation is the oven owner’s responsibility.

The ventilation hood must operate in harmony with the building HVAC system. It typically requires between 1200 and 3500 CFM exhaust. (The “Efficiency” of various hood designs makes it necessary to specify such a wide range of ventilator CFM.) Make up air must be supplied by either a hood design or the HVAC system. This will vary with hoods from various manufacturers.

*CAUTION: Prevent airflow through the cooking tunnel. Air must NOT be directed onto the oven front or at side of cooking area or rear of oven.*

Performance will be evaluated during Start-up Checkout by conducting a smoke candle test. The hood must capture all smoke from the oven. This is required to assure proper performance of the oven and to eliminate additional service calls that occur when ambient temperatures are too high. In all cases, the ambient temperature around the oven must be less than 95° F / 35° C when the oven is operating. In certain localities, other chemical or gaseous methods of detecting adequate capture will be the requirement to meet the local code authority.

The drawing shown on the next page is a typical installation and is intended to be a guideline. It is not a rigid specification. Hood dimensions and the positioning of the hood over the oven will vary with hood manufacturers.

NOTE: Lincoln can provide oven spec sheets that show the dimensions of the oven, KW or BTU ratings and other information that will be useful to both the ventilation hood supplier and the HVAC contractor.

*IN AUSTRALIA:* Refer to Standard AS 5601. This standard specifies the requirements for piping, flueing, ventilation and appliance installation associated with use of or intended use of fuel gases. The requirements of AS 5601 are to be used in conjunction with, but do not take precedence over, any statutory regulations that may apply in any area.

**LINCOLN IMPINGER® OVEN, MODEL SERIES 1400  
DOUBLE DECK OR SINGLE UNIT CANOPY VENTILATION RECOMMENDATIONS**

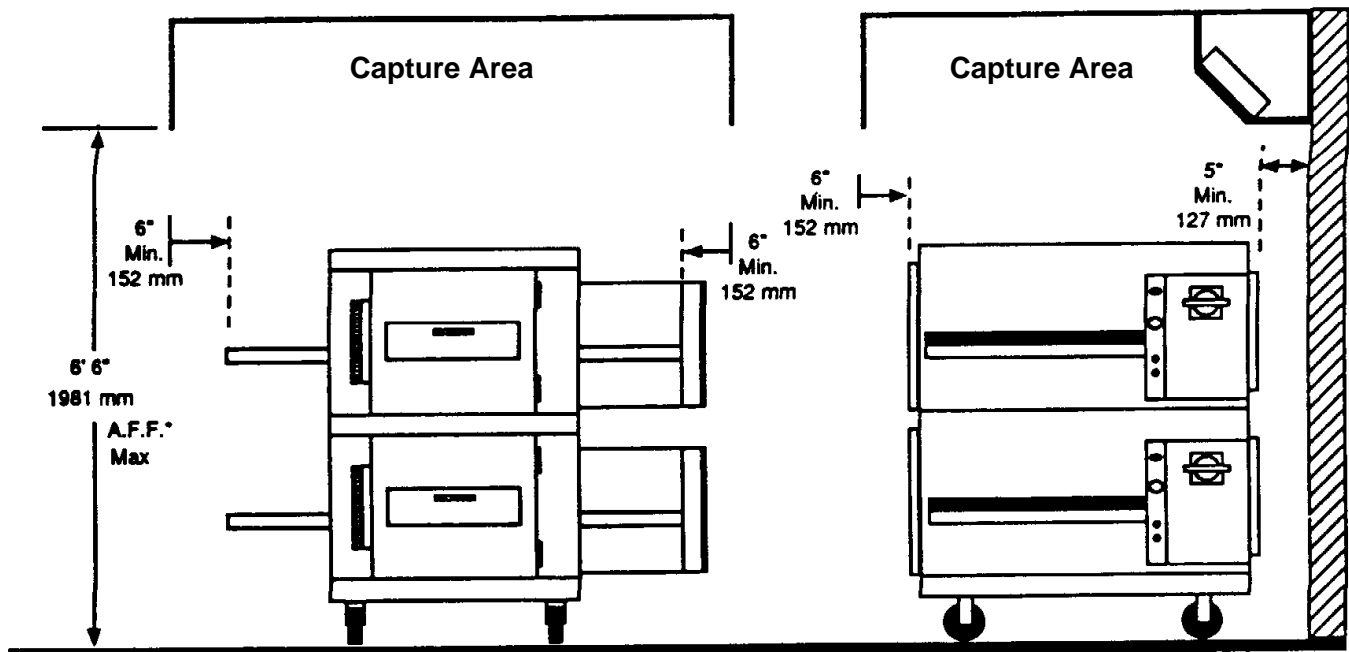

\* AFF = Above Finished Floor

**SMOKE CANDLE TEST – VENTILATION SYSTEM VERIFICATION**

OVEN SET-UP FOR THIS TEST:

1. This test is to be done on the bottom oven of a multiple oven system, or a single oven.
2. The conveyor must be off.
3. The oven temperature must be set and operating at 550°F/288°C.

TEST PROCEDURE:

Note: Use Lincoln Smoke Candle #369361 (in Australia, an alternate method of coloring the air may be used).

1. Wear heat resistant gloves to prevent burns to your hands.
2. Put the smoke candle in a cake pan approximately 8 inches (200 mm) x 8 inches (200 mm) x 2 inches (50 mm) deep or equivalent.
3. Open the optional access window in the oven door, or insert candle through conveyor opening.
4. Light the fuse of the smoke candle and immediately put the pan and candle into the center of the oven cavity, on the conveyor belt. (Close the access window or door.)
5. Observe the smoke pattern coming out of the oven openings and the collection of this smoke by the ventilation system.
6. The ventilation system must capture all the smoke from the oven.

## MANUAL GAS VALVE INSTALLATION

When installing the gas valve that is supplied with the oven, as shown in the drawing to the right, it is our suggestion that an elbow be placed on the oven pipe first. This will allow the flexible hose to be attached in a downward direction eliminating possible stress to the hose.

### SPECIFICATIONS

Body: Stainless Steel  
Power: Gas and/or Electric  
DB Level:  $\leq 71$ dba  
Operating Temperature Range: 300° - 600° F  
(149° - 316° C)

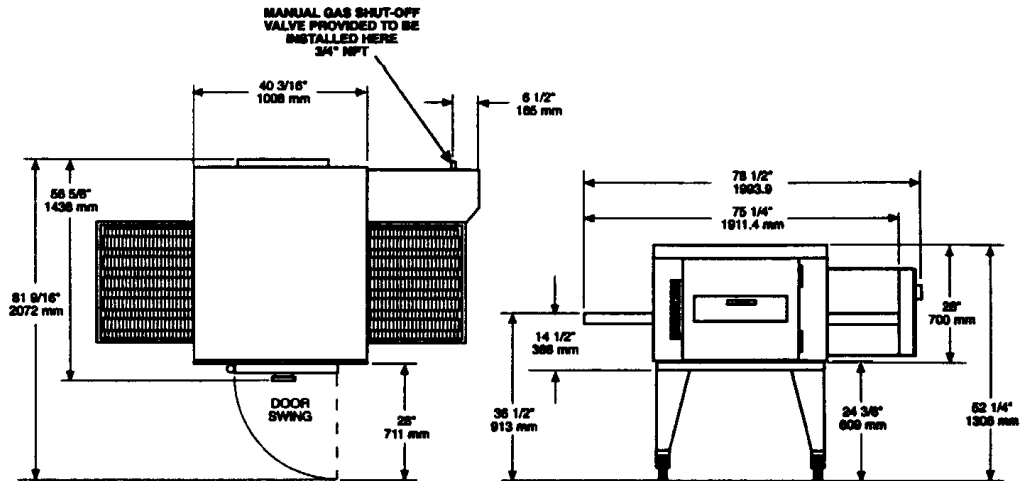

### WARNING INT'L (CE):

This appliance must be properly grounded at time of installation. Failure to ensure that this equipment is properly grounded can result in electrocution, dismemberment or fatal injury.

## CODE REFERENCE

### GAS CODE REFERENCE

Safe and satisfactory operation of this oven depends to a great extent upon its proper installation, and it should be installed, as applicable in accordance with the National Fuel Gas Codes, ANSI Z223.1/NFPA 54, latest version, Manufacturers' installation Instructions and local municipal building codes.

1. The oven and its individual shut off valve must be disconnected from the gas supply piping system during any pressure testing of that system at test pressures in excess of 1/2 psig (3.45kPa).
2. The oven must be isolated from the gas supply piping system by closing its individual manual shut off valve during any pressure testing of the gas supply system at test pressures equal to or less than 1/2 psig (3.45kPa).

IN MASSACHUSETTS: The minimum length of a flexible gas supply hose is thirty-six (36") inches.

IN CANADA: The installation of these appliances is to be in accordance with CSA B.149.1 latest version – Natural Gas and Propane Installation Code – and/or local codes.

IN AUSTRALIA: To be installed in accordance with AS 5601-2004 and 4563-2004 Gas Installation Code.

### ELECTRICAL CODE REFERENCE

When installed, this appliance must be electrically grounded and its installation must comply with the National Electric Code, ANSI-NFPA 70, latest edition, the Manufacturers' Installation Instructions, and applicable local municipal building codes.

IN CANADA: All electrical connections are to be made in accordance with CSA C22.2 latest version – Canadian Electrical Code and/or local codes.

ALL OTHER COUNTRIES: Local gas and/or electrical codes will prevail.

1. Strain Relief is provided with each oven. International Dealer/Distributors provide applicable power cord/plug for each customer.
2. All pole disconnection switch 3mm open contact distance.
3. To prevent electrical shock, an equal potential bonding ground lug is provided in the back. This allows the oven to be connected to an external bonding system.
4. If used as double or triple stack and each oven has its own disconnection switch, all switches should be close together.

## RESTRAINT REQUIREMENT – GAS OVEN(S) ON CASTERS, U.S. AND AUSTRALIA

1. The installation shall be made with a gas connector that complies with the Standard for Connectors for Movable Gas Appliances, ANSI Z21.69 latest version, and a quick disconnect device that complies with the Standard for Quick Disconnect Devices for Use With Gas Fuel, ANSI Z21.41 latest version.

IN CANADA: The installation shall be made with gas connectors that comply with Canadian Code CSA 6.16 latest version and quick disconnects complying to Canadian Code CSA 6.9 latest version.

IN AUSTRALIA: To be installed in accordance with AS 5601-2004 and 4563-2004 Gas Installation Code.

2. The installation of the restraint must limit the movement of the oven(s) without depending on the connector, the quick disconnect device or its associated piping to limit the oven movement.
3. If the restraint must be disconnected during maintenance or cleaning, it must be reconnected after the oven has been returned to its originally installed position.

## OPERATIONS

1. Screw lifting eye “B” of cable assembly to hole “A”.
2. Screw eye bolt “C” of cable assembly to stud in wall “D” or floor anchor “E”.

**NOTE: Installation point is the same for single and double stack oven(s).**

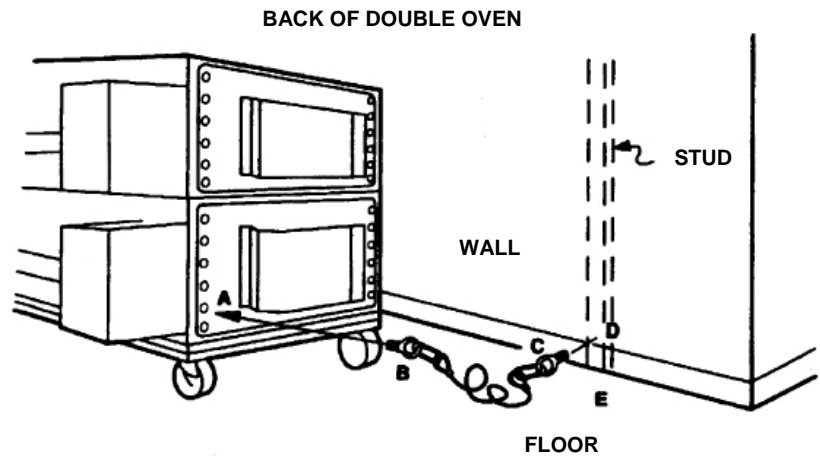

## PROGRAMMING (QUEST UNITS ONLY)



Quest EMS Energy Management System by Lincoln Foodservice Products is a unique energy saving system designed to optimize the performance of a gas or electric powered burner focused to save 40% to 65% energy at idle conditions. Significant energy savings for accelerated impingement ovens are achieved through the complementary effects of reduced fan rpm, optimized burner or electric control settings, and reduced volume impingement air flow.

## QUEST OPERATING INSTRUCTIONS

1. Press button on control box side panel to illuminate button and engage the Quest energy savings option. The oven is now in energy savings mode.
2. To bring the oven out of energy savings mode, simply press the button again to allow for normal operation. Notice that with the oven back in normal operating mode, the side panel button is no longer illuminated.

**NOTE:** When starting up the oven after the Quest system has been installed, the main fan may take upwards of sixty seconds to begin running. This is normal operating procedure.

## PROGRAMMING (CONT'D)

(ALL MODELS)

### INTRODUCTION – START-UP AND SHUT DOWN

For the operator, the panel has a power up, run, and program menu modes. To start the oven, turn the power switch on. To shut down the oven, turn the power switch off.

### FRONT PANEL LAYOUT

The front panel contains four (4) momentary push-buttons: TEMP, TIME, UP & DOWN. There is a 2 line x 16 character VFD display.

### TEMPERATURE SETPOINTS

For Digital Advantage ovens, there is one setpoint. To enter the setpoint mode, press the TIME & TEMP buttons together and hold for 5 seconds. Pressing the UP or DOWN push-buttons will raise or lower the temperature to the desired setting. In the Fahrenheit, F mode, the temperature is adjusted in 5 degree increments. When in Centigrade, C mode, the temperature adjustment will be in 1 degree increments. Pressing and holding the UP or DOWN keys will allow the settings to “roll” at a much faster rate. When the desired temperature is indicated, release all keys. After 5 seconds, the selected setpoints will be stored and remain in memory.

### TIME SETPOINTS

There is one setpoint for the conveyor speed. Enter the setpoint mode as mentioned above. The speed can be set as follows:

- 1:00 to 9:55 in 5 second increments
- 10:00 to 12:45 in 15 second increments
- 13:00 to 19:30 in 30 second increments
- 20:00 to 30:00 in 1 minute increments

### JUMPING BETWEEN MENUS

Pressing the TIME push-button while in the TEMP setting mode (and vice versa) will cause the menu selection to jump over to that mode.

### DIAGNOSTIC MESSAGES

The Digital Advantage ovens have diagnostic messages within the control. In the unexpected event that there is a failure in the oven operation, the following messages will appear in the control.

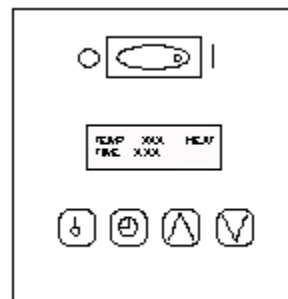

### OPEN PROBE

This occurs when there is no temperature being sent to the controller from the baking chamber.

### SHORTED PROBE

This occurs when a constant temperature signal (as opposed to the normal cyclical cavity temperature) is being sent to the controller from the baking chamber. *CAUTION: This message can also occur when there is no gas supply to the oven. If the oven does not detect a temperature fluctuation in 5 minutes, the error message will appear. Be sure to check the gas valve and gas hose for proper connections.*

### BELT JAM

This occurs when the conveyor motor fails.

### REVERSING SWITCH

The oven has a belt direction-reversing switch located on the back of the control box.

## FUNCTIONS

### THERMAL CUT-OUT SWITCH

The Impinger I unit includes a “safety thermal cut-out switch” for your protection. This safety related device is designed to insure that the Impinger I unit will not overheat and damage the unit. In the unlikely event that the Impinger I unit would exceed the specified operating temperature range, the “safety thermal cut-out switch” will activate, thus blocking power to the Impinger I unit and causing it to turn off.



### **CAUTION:**

In order to avoid a hazard due to inadvertent resetting of the thermal cutout, this appliance must not be supplied through an external switching device such as a timer or connected to a circuit that is regularly switched on and off by the utility.

## FINGER REMOVAL AND DISASSEMBLY FOR CLEANING

1. Open door and remove upper fingers. Note any particular placement of fingers that you may have, such as fully closed, half-closed, or fully open, columnating plates.
2. Remove conveyor and then remove bottom fingers.
3. For finger disassembly, see "Stand and Finger Assembly" section.
4. Reassemble fingers in reverse order with the step of the columnating plate facing downward so it fits under the lip of the finger housing.
5. Re-install finger in oven. Be sure that they are fully seated over the plenum flanges and the holes are pointing toward the conveyor.

## CONVEYOR REMOVAL FOR CLEANING

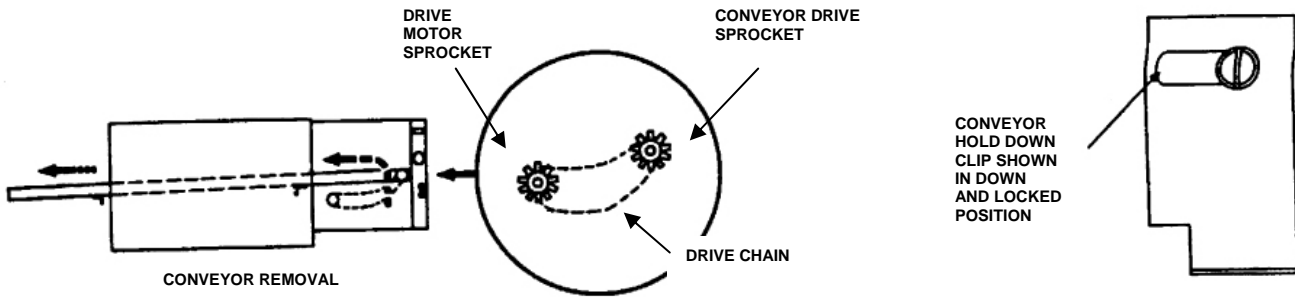

1. Remove conveyor chain guard. Remove crumb pans.
2. Next, slide the conveyor hold-down clips so the screw is in the left side of the slot, then rotate counterclockwise to the up position.
3. Lift right end of conveyor and push in approximately 3" (76 mm). Remove drive chain.
4. Pull conveyor out the right end. Place on table or work surface.

## CONVEYOR INSTALLATION

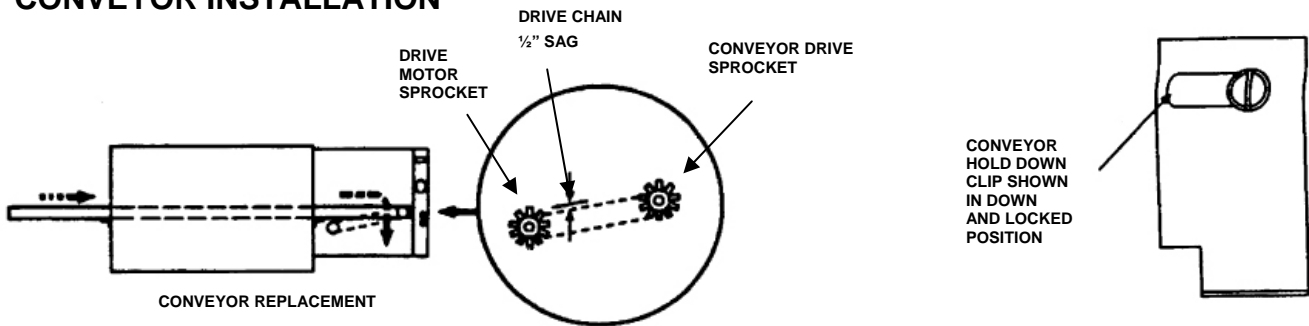

1. Insert the conveyor through the opening in the right side. Sprocket should be to the right side of the conveyor.
2. Slide conveyor through the oven chamber until the locking bar on driving end of the conveyor is approximately 2" – 3" (50 – 76 mm) into the oven chamber. Install drive chain by placing it over the driving sprocket and placing it over the conveyor sprocket.
3. Lift conveyor just enough to allow you to pull the conveyor toward you until the locking bar is outside of the oven cavity, at the same time push the conveyor downward so that the bar locks on the outside of the oven wall. Next, slide the conveyor hold-down clips so the screw head is in the left side of the slot, rotate clip clockwise to down position and slide so the screw head is in right side of the slot to lock.
4. Reinstall conveyor crumb pans and chain guard cover.



### CAUTION:

Set tension on conveyor belt. The belt should be able to be lifted enough to allow it to be 1/4" (6mm) from the top of the conveyor opening on the oven. Do not over-tighten the belt.

## OPERATOR MAINTENANCE



### WARNING!



Disconnect power supply before servicing or cleaning this oven. Safeguard power so it cannot be accidentally restored. Failure to do so could result in dismemberment, electrocution, or fatal injury. There is more than one power supply connection point when ovens are stacked. Make sure that all switches are in the "OFF" position before cleaning or maintenance.

To maintain maximum efficiency of the oven, it is necessary to keep it clean, all ventilation louvers on the oven must be cleaned regularly. Oven use and type of product will actually determine the frequency of cleaning. The conveyor drive chain should be checked during the weekly cleaning cycle to see if it has become loose. Loose chain operation will DAMAGE the conveyor drive motor.

If the oven fails to operate, check the circuit breaker to be sure it is turned on. Also, check the fuses on the control panel to be sure that they are good before you call the Authorized Service Agency. The name and phone number of the Authorized Service Agency should be located at the bottom of the data plate.

## CLEANING INSTRUCTIONS



### CAUTION:

Oven must be cool. Do not use power cleaning equipment, steel wool or wire brushes on stainless steel surfaces.



### CAUTION:

Do not use caustic or alkaline cleaners on the interior of the unit. These cleaners can damage the specially finished surfaces of the unit interior.



### CAUTION:

When using cleaning solutions, be sure they meet local and national health standards.

### DAILY

1. Clean exterior surfaces of the oven by wiping it down with a mild detergent and clean water, or a commercial stainless cleaner.
2. Clean crumb pans and guards by washing with a mild detergent solution and rinsing with clean water.
3. Clean the interior by sweeping up all loose particles, then wash with a mild detergent solution and rinse with clean water.
4. Clean the conveyor belt by wiping with a clean cloth or brushing with a soft wire brush. Lincoln catalog #369217.

On exterior of oven, deposits of baked-on splatter, oil, grease, or light discoloration may be removed with any of several commercial cleaners. Consult with your local supplier.

### WEEKLY

1. Remove fingers, disassemble and clean. See "Finger Removal" section for more information.
  2. Remove conveyor, disassemble and clean. See "Conveyor Disassembly" section for more information.
- NOTE: Be sure to clean and inspect the ventilation hood in accordance with the ventilation hood manufacturer's specifications.



## **SCHEDULED PREVENTIVE MAINTENANCE (BY QUALIFIED SERVICE AGENCY ONLY)**

Although this oven has been designed to be as trouble-free as possible, periodic preventive maintenance is essential to maintain peak performance. It is necessary to keep the motors, fans, and electronic controls free of dirt, dust and debris to insure proper cooling. Overheating is detrimental to the life of all components mentioned.

*Failure to perform scheduled maintenance may result in component failure that is not covered by warranty.*

### Recommended Bi-Annual Service

- Check utilities for compliance to manufacturer's specifications, voltages, amperage, gas pressure, and ground connection.
- Check time/temp calibration
- Check conveyor for tension, tracking of conveyor, bearing wear, belt damage, and drive train tension
- Visually inspect unit for damaged, broken, or inoperative components (i.e. switches, dials, plug/receptacle, etc.)
- Check for correct installation and positioning of unit to manufacturer's specifications (a smoke candle test must be used for verification of hood operations).
- Clean control box internally
- Check gas pressure before and after regulator specific to manufacturer's specification.
- Check flame quality and adjust air shutter, if necessary.

### Recommended Annual Service

- Check burner blower for signs of bearing chatter or excessive vibration. Clean burner blower of dust and debris.
- Check burner for correct positioning of flame target and sheet metal sides of the igniter assembly.
- Inspect pilot orifice and clean. Check igniter/sensor for damage and aging. Replace if necessary.

## **STACKING THE 1400 SERIES WITH OTHER IMPINGER® OVENS**

The model 1400 Series units may be mounted on either a 1000 (Impinger® I) or a 1200 (Impinger® III) with the addition of a flue cap, part #1456, (Supplied with the oven) to the bottom unit. Since the 1400 Series units are flueless, they may be mounted below an Impinger® I or III without a flue extension. The 1400 Series units are not approved to be mounted with, on, or below any equipment except an indicated above.

**DO NOT ATTEMPT TO OPERATE THE OVEN** until connection of utility service and installation has been fully inspected (START-UP CHECKOUT) by an Authorized Service Technician or a Lincoln Foodservice Products Service Representative. This service is required by Lincoln Foodservice Products in order to insure the oven(s) is properly installed and in working order. The warranty becomes effective upon verification of proper installation.

The warranty shall not apply if the oven(s) are started up and operated prior to the "START-UP CHECKOUT" being performed by an Authorized Service Technician or a Lincoln Foodservice Products Service Representative.



### **WARNING:**

If the supply cord appears to be damaged, do not attempt to operate the unit. Contact a service agent or qualified electrician to repair.

## **HOW TO OBTAIN SERVICE**

If the oven fails to operate, check the circuit breaker to be sure it is turned on (on a gas oven check the manual gas valve to insure it is in the ON position) and check the fuses on the back of the oven to be sure they are good before you call the Authorized Service Agency. The name and phone number of the Authorized Service Agency should be located on the oven or contact the factory at (800) 678-9511 for the name of the nearest agency.

# APPENDIX A – LABEL DEFINITIONS



CAUTION – HOT SURFACE



POWER ON



CLOCK, TIME SWITCH, TIMER

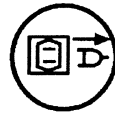

DISCONNECT POWER



TRANSFORMER



TEMPERATURE, HEAT



DANGEROUS VOLTAGE

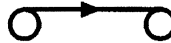

CONVEYOR



EQUIPOTENTIALITY GROUND



FAN



PROTECTIVE EARTH GROUND

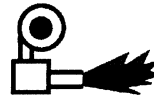

BURNER



EARTH GROUND



HEAT CYCLE

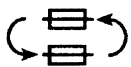

CHANGE FUSES



READY, TIMER INDICATOR

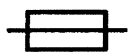

FUSE



RESET



POWER OFF



HIGH TEMPERATURE, HEAT

**APPENDIX A – LABEL DEFINITIONS (CONT'D)**

**A**

AMPS

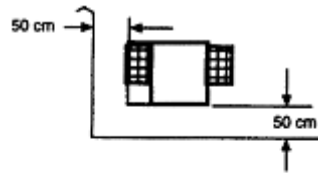

SERVICE ACCESSIBILITY, PROVIDE MINIMUM REAR AND SIDE CLEARANCE

**V**

VOLTS



ORIFICE – MAIN

**kW**

KILOWATTS / HR



ORIFICE – LOW FIRE



TYPE OF GAS



AC

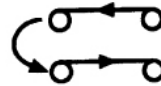

MODEL SERIES 1400  
NOTE: TO REVERSE DIRECTION OF CONVEYOR SWITCH WIRE # 24 (A-) WITH #30 (A+)

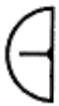

1/2 COOK TIME



ALARM, BURNER FLAME OUT

## LIMITED WARRANTY FOR COMMERCIAL PRODUCTS

### LIMITED WARRANTY

Lincoln Foodservice Products, LLC ("Lincoln") warrants this product to be free from defects in material and workmanship for a period of one (1) year from the date of purchase.

During the warranty period, Lincoln shall, at Lincoln's option, repair, or replace parts determined by Lincoln to be defective in material or workmanship, and with respect to services, shall re-perform any defective portion of said services. The foregoing shall be the sole obligation of Lincoln under this Limited Warranty with respect to the equipment, products, and services. With respect to equipment, materials, parts and accessories manufactured by others, Lincoln's sole obligation shall be to use reasonable efforts to obtain the full benefit of the manufacturer's warranties. Lincoln shall have no liability, whether in contract, tort, negligence, or otherwise, with respect to non-Lincoln manufactured products.

### WHO IS COVERED

This Limited Warranty is available only to the original purchaser of the product and is not transferable.

### EXCLUSIONS FROM COVERAGE

- Repair or replacement of parts required because of misuse, improper care or storage, negligence, alteration, accident, use of incompatible supplies or lack of specified maintenance shall be excluded
- Normal maintenance items, including but not limited to, light bulbs, fuses, gaskets, O-rings, interior and exterior finishes, lubrication, conveyor belt, motor bushes, broken glass, etc. adjustments and calibrations for temperatures, speed and air flows
- Failures caused by improper or erratic voltages
- Improper or unauthorized repair
- Changes in adjustment and calibration after ninety (90) days from equipment installation date
- This Limited Warranty will not apply to any parts subject to damage beyond the control of Lincoln, or to equipment which has been subject to alteration, misuse or improper installation, accidents, damage in shipment, fire, floods, power changes, other hazards or acts of God that are beyond the control of Lincoln
- This Limited Warranty does not apply, and shall not cover any products or equipment manufactured or sold by Lincoln when such products or commercial equipment is installed or used in a residential or non-commercial application. Installations not within the applicable building or fire codes render this Limited Warranty and any responsibility or obligations associated therein null and void. This includes any damage, costs, or legal actions resulting from the installation of any Lincoln commercial cooking equipment in a non-commercial application or installation, where the equipment is being used for applications other than those approved for by Lincoln.

### LIMITATIONS OF LIABILITY

The preceding paragraphs set forth the exclusive remedy for all claims based on failure of, or defect in, products or services sold hereunder, whether the failure or defect arises before or during the warranty period, and whether a claim, however instituted, is based on contract, indemnity, warranty, tort (including negligence), strict liability, implied by statute, common-law or otherwise, and Lincoln its servants and agents shall not be liable for any claims for personal injuries, incidental or consequential damages or loss, howsoever caused. Upon the expiration of the warranty period, all such liability shall terminate. THE FOREGOING WARRANTIES ARE EXCLUSIVE AND IN LIEU OF ALL OTHER WARRANTIES, WHETHER WRITTEN, ORAL, IMPLIED OR STATUTORY NO IMPLIED WARRANTY OF MERCHANTABILITY OR FITNESS FOR PARTICULAR PURPOSE SHALL APPLY. LINCOLN DOES NOT WARRANT ANY PRODUCTS OR SERVICES OF OTHERS.

### REMEDIES

The liability of Lincoln for breach of any warranty obligation hereunder is limited to: (i) the repair or replacement of the equipment on which the liability is based, or with respect to services, re-performance of the services; or (ii) at Lincoln's option, the refund of the amount paid for said equipment or services.

Any breach by Lincoln with respect to any item or unit of equipment or services shall be deemed a breach with respect to that item or unit or service only

### WARRANTY CLAIM PROCEDURE

Customer shall be responsible to:

- Immediately advise the Dealer or Lincoln's Authorized Service Agent of the equipment serial number and the nature of the problem.
- Verify the problem is a factory responsibility. Improper installation or misuse of equipment, are not covered under this Limited Warranty.
- Cooperate with the Service Agency so that warranty service may be completed during normal working hours.
- Travel Time not to exceed two hours and mileage not to exceed one hundred (100) miles.

### GOVERNING LAW

Limited Warranty shall be governed by the laws of the state of Delaware, USA, excluding their conflicts of law principles. The United Nations Convention on Contracts for the International Sale of Goods is hereby excluded in its entirety from application to this Limited Warranty

Lincoln Foodservice Products, LLC  
1111 North Hadley Road  
Fort Wayne, Indiana 46804  
USA  
www.lincolnfp.com

This page intentionally left blank.

This page intentionally left blank.

This page intentionally left blank.

