



---

# MIBRASA® ROBATAYAKI

## USER MANUAL

---

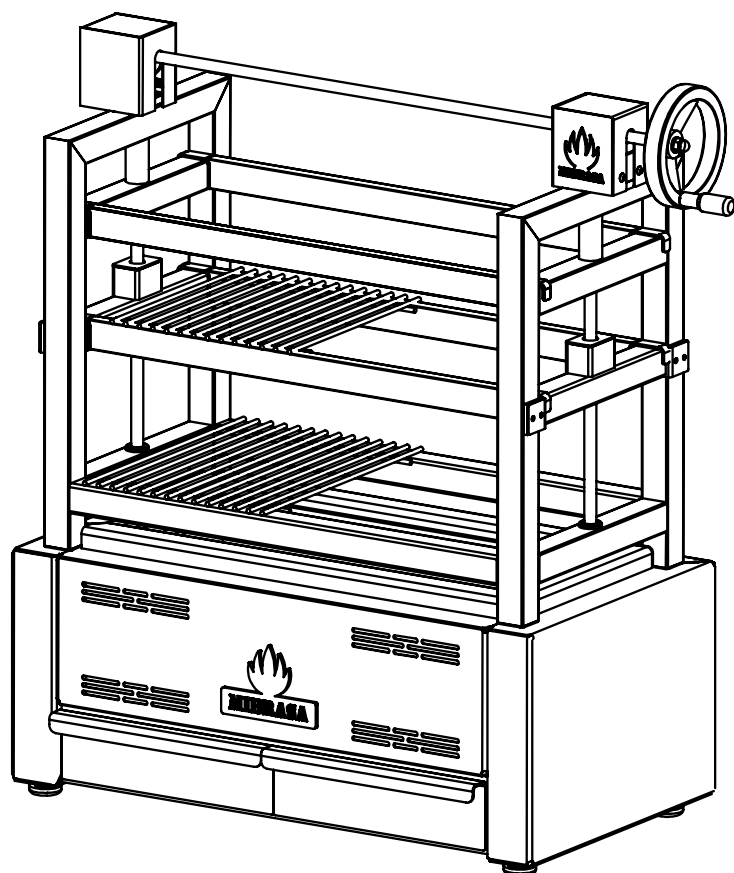

Read all instructions before installing and using the appliance.  
Save these instructions.

[www.mibrasa.com](http://www.mibrasa.com)

*Feeding the Senses!*



## Contents

1. Introduction	1
2. Mibrasa® Robatayaki dimensions	2
2.1. RM Model	
2.2. RM SE Model	
3. Parts of the Robatayaki	4
4. Installation instructions	6
4.1. Installation guidelines and safety standards	
5. Lighting up	7
6. Robatayaki operation	7
7. Maintenance and safety standards	8
7.1. Daily cleaning	
7.2. Special care	
7.3. Safety standards	
8. General conditions	10
8.1. Warranty	
8.2. Returns	
8.3. Property Reserve	

# 1. Introduction

---

Originating from the Japanese tea ceremony, which overtime found its way to the north Japanese fishermen utilizing this method to keep food hot while out at sea for long periods. The evolution of the Robatayaki has brought it into the modern kitchen, where chefs prepare the food and display their showmanship in front of diners allowing them to take part in the entire cooking experience.

The Mibrasa® Robatayaki is manufactured with steels of the latest technology following the most rigorous quality controls. Like all Mibrasa® units, they comply to the strict standards & regulations set by internationally recognised certifications of quality.



## Our Robatayakis

A multi-tier open charcoal grill equipped with accessories to perform a range of cooking techniques using grills, Teppanyaki hot plates or skewers. Robata grilling lends itself to an array of foods from meat, fish, seafood and vegetables, imparting light smoky aromas and flavours we seek in grill cooking.

Mibrasa® Robatayaki RM SE (with elevating system), designed and patented by Mibrasa® enables height adjustments between the grill and hot coals to provide the chef with total control allowing them to cook with more efficiency.

## 2. Mibrasa® Robotayaki dimensions

### 2.1. RM Model

Model	A	B	C	D	E	F	G	H	I	J	K	L
RM 60	520	480	620	390	210	345	180	90	445	470	330	800
RM 80	700	660	800	570	210	345	180	90	445	470	330	800
RM 115	1045	1005	1145	920	210	345	180	90	445	470	330	800

Dimensions in mm

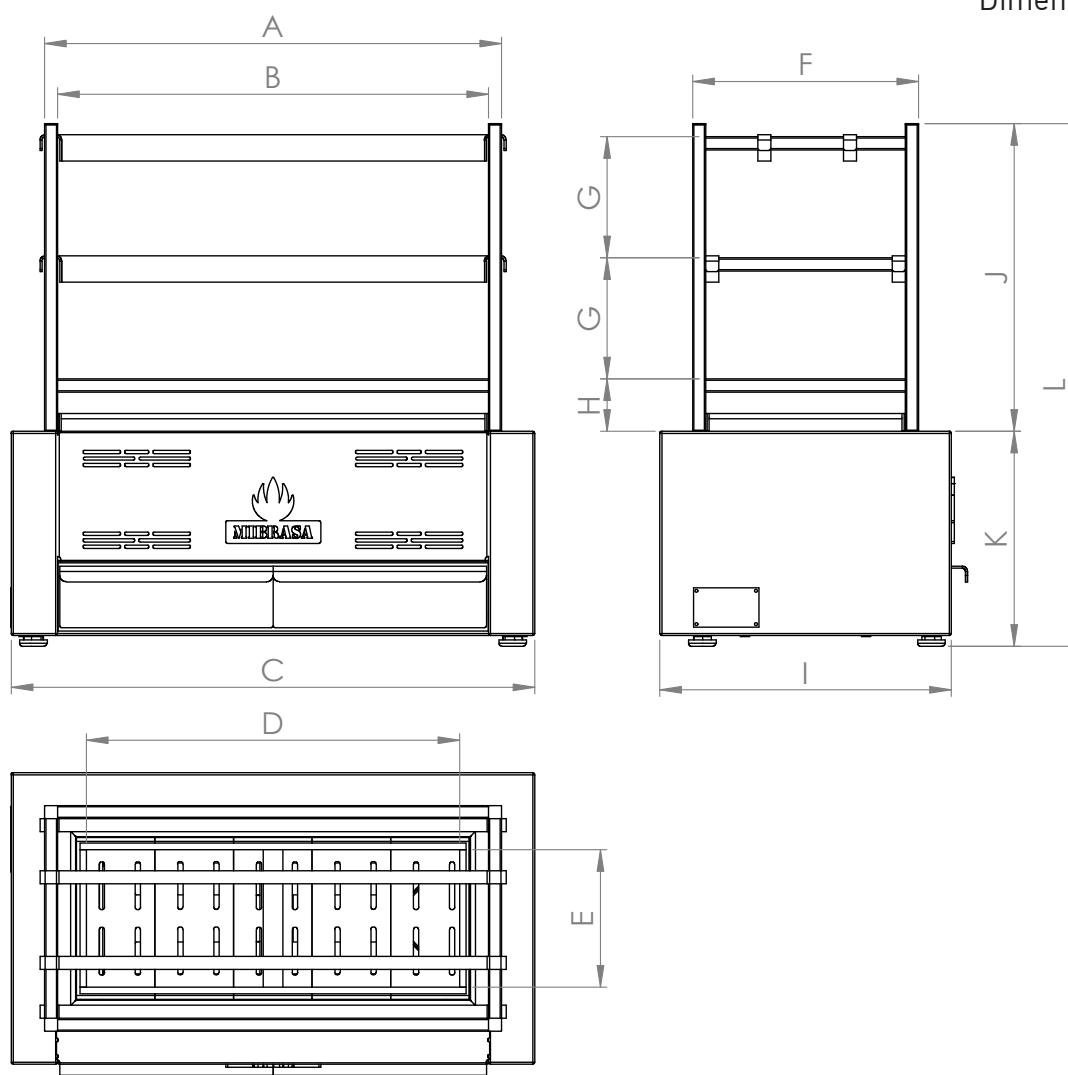

### Ventilation recommendations

Model	Flow rate (m <sup>3</sup> /h)	Hood dimensions (Width x depth in mm)	Minimum height of hood from floor (mm)
RM 60	2200	1000 x 1000	2000
RM 80	2500	1200 x 1000	2000
RM 115	3000	1500 x 1000	2000

## 2.2. RM SE Model

Model	A	B	C	D	E	F	G	H	I	J	K	L	M
RM SE 60	820	480	620	390	210	385	150	550	330	445	1030	360	90
RM SE 80	1000	660	800	570	210	385	150	550	330	445	1030	360	90
RM SE 115	1345	1005	1145	920	210	385	150	550	330	445	1030	360	90

Dimensions in mm

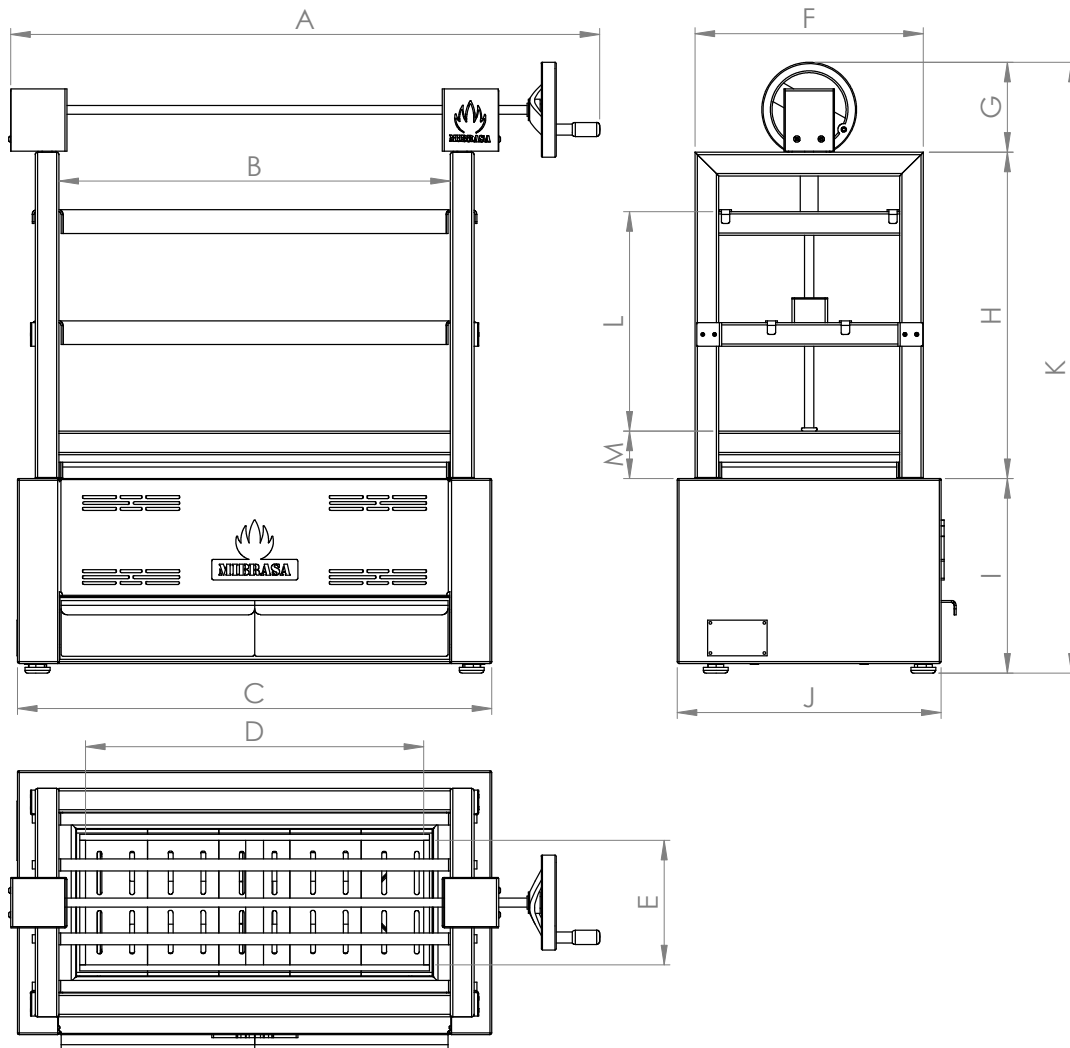

### Ventilation recommendations

Model	Flow rate (m <sup>3</sup> /h)	Hood dimensions (Width x depth in mm)	Minimum height of hood from floor (mm)
RM SE 60	2200	1000 x 1000	2000
RM SE 80	2500	1200 x 1000	2000
RM SE 115	3000	1500 x 1000	2000

### 3. Parts of the Mibrasa® Robotayaki

---

1.a Structure

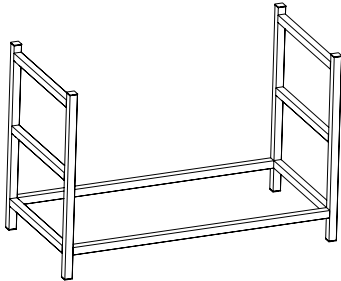

1.b Structure with elevating system

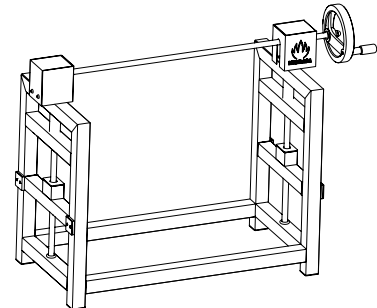

2. Support bars

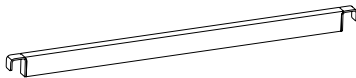

3. Burning pit

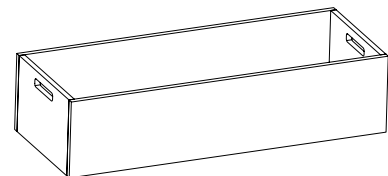

4. Charcoal grid

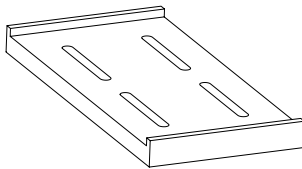

5. Main body

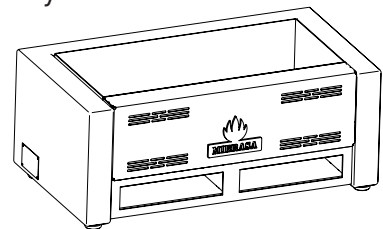

6. Interior body

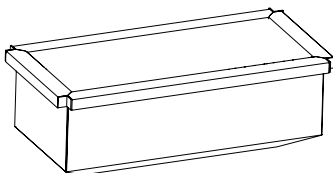

7. Ash collector

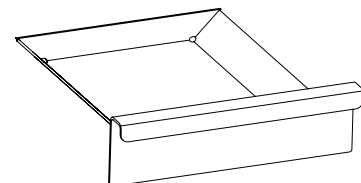

8. Grill

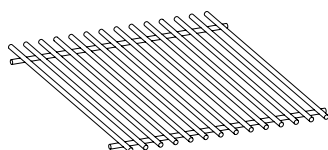

The Mibrasa® Robotayaki is subject to technical and design changes.

## Included accessories:

Top and lower grills\*

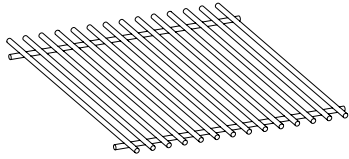

\*The 115 series includes 2 top grills and 2 lower grills

Support bars (x4)

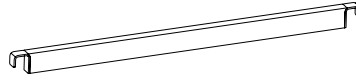

Mibrasa tongs

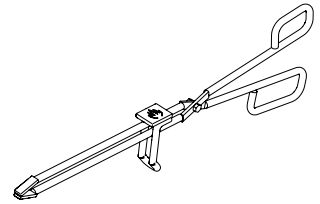

Ash shovel

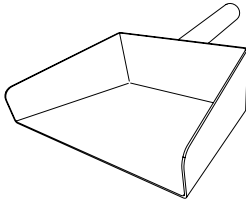

Ember poker

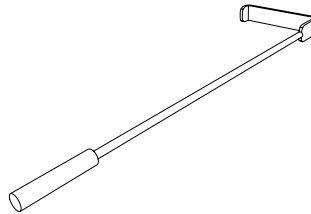

Grill brush

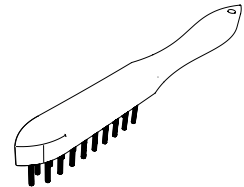

Mibrasa Ecofire firelighters

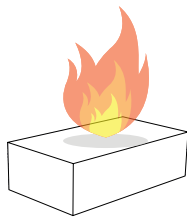

## Optional accessories:

- Top mesh grill
- Lower mesh grill
- Support bars (2)
- Flat top Teppanyaki griddle
- Perforated Teppanyaki griddle
- Robotayaki stand
- Robotayaki drop-leaf stand
- Lid for end of service
- Stainless steel skewers 20 and 30cm
- Kitchenware (consult online catalogue at [www.mibrasa.com](http://www.mibrasa.com))



## 4. Installation instructions

- 1 Dismantle the structure    2 Take out the burning pit    3 Remove the charcoal grids

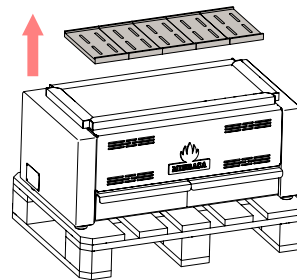
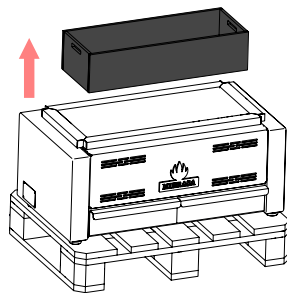
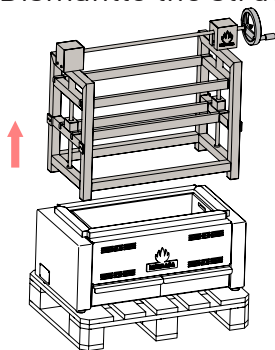

- 4 Place the main body on top of the stand    5 Replace all the elements    6 Ready to work

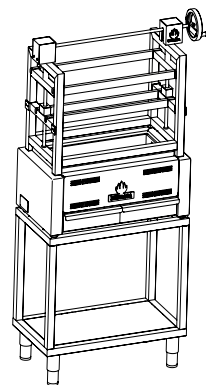
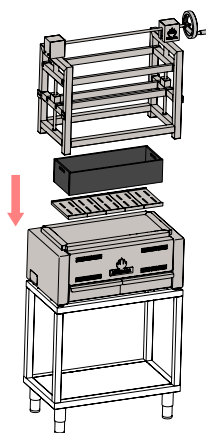
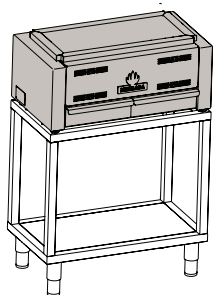

### 4.1 Installation and safety standards

- Do not place combustible materials within a distance of 300mm from the bottom, rear or side of the Mibrasa® Robotayaki.
- Clearances to construction/other appliances: Unit to back and sidewalls: 100mm.
- Workspace for the chef and recommended height of the worktop:

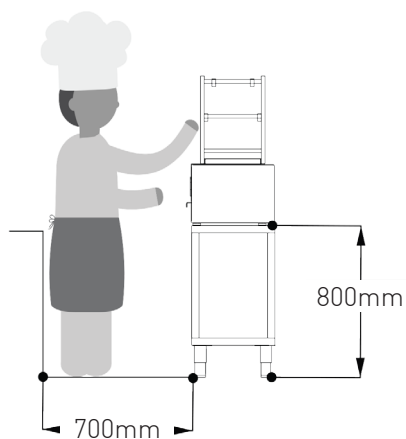

## 5. Lighting up

1 Remove the grills

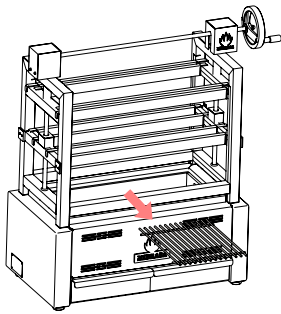

2 Load the charcoal

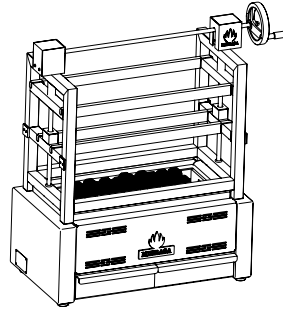

3 Open the ash collector

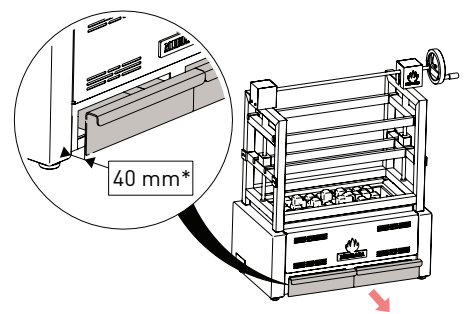

4 Place and light the Eco-fire firelighters

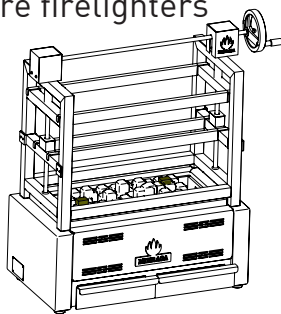

5 Close the ash collector

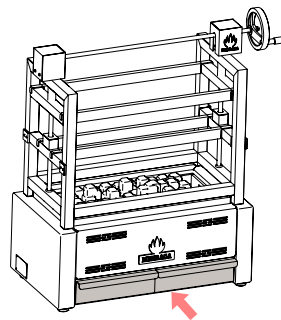

6 Ready to cook

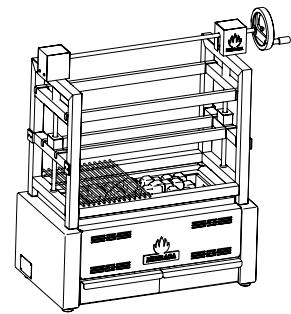

Approximate quantity of charcoal according to Robotayaki model:

Model	Initial charcoal load
60	3 Kg
80	4 Kg
115	7 Kg

## 6. Robotayaki Operation

Level	Code	Description	Max. no. grills level		
			RM 60 / RM SE 60	RM 80 / RM SE 80	RM 115 / RM SE 115
1	RLG	Lower grill	1	2	3
	LGM	Lower mesh grill			
	FTTG	Flat top Teppanyaki griddle			
	PTG	Perforated Teppanyaki griddle			
2 / 3	RTG	Top grill	1	2	3
	TGM	Top mesh grill			

Elevation system operation:

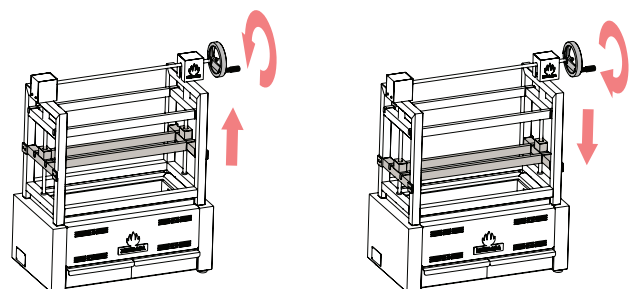

## 7. Maintenance and safety standards

---

### 7.1. Daily cleaning

Do not use chemical products or water to clean the inside of the Robotayaki.

**Grills:** Clean using the grill brush before and after each use.

**Ash collector:** Open the ash collector, use the ash shovel by Mibrasa® to remove the ash and transfer to a metal container with a tight-fitted lid. We recommend completely removing the ash collector from the Robotayaki once a week to facilitate cleaning. Once the ashes have completely cooled down they can be used as fertilizer.

**WARNING** Do not dispose the ashes in a flammable-container or heat-deformable container.

### 7.2. Special care

**Exhaust hood and ductwork:** It is very important to keep the exhaust hood filters clean as well as the interior and ducts, to avoid a build up of soot and fat, which could result in a possible fire.

Follow the weekly cleaning procedures and annual maintenance of the hood, ventilation box and flue ducts in accordance to the exhaust hood manufacturer's requirements. Pulverisation water filtration systems are also accepted to compliment the use of this Robotayaki. The ductwork should be inspected at least twice a year to determine when creosote build up has occurred.

Mibrasa® is not responsible for any damages occurred caused by wrongful use, when the installation instructions have not been followed or wrongful maintenance of the exhaust hood.

Please read this entire manual before you install the Robotayaki.  
Failure to follow instructions may result in property damage, bodily injury, or even death.

### 7.3. Safety standards

- Only use charcoal in the Mibrasa® Robotayaki.
- The first time the Robotayaki is used do not cook food for at least one hour after lighting.
- Proceed with reasonable care when operating a Mibrasa® Robotayaki. Never leave it unattended when lit.
- **CAUTION** Do not overload/fire. Consult the charcoal loads in the chart in point 5.
- Disposal of ashes – Ashes should be placed in a metal container with a tight-fitting lid. The closed container of ashes should be placed on a non-combustible floor or on the ground, well away from all combustible materials, pending final disposal. When the ashes are disposed by burial in soil or otherwise locally dispersed, they should be retained in the closed container until all cinders have thoroughly cooled.
- Do not attempt to pour water over the hot coals.
- Do not clean the Robotayaki when it is in operation or still hot.
- Do not use chemical products to clean the exterior of the Robotayaki when in use or hot.

### DANGERS

- When this Robotayaki is not properly installed, a fire may result. To reduce the risk of fire, follow the installation instructions.
- Keep children and pets away from the oven and flammable products. Accessible parts of the Robotayaki may be very hot.
- Do not use alcohol, oil or other liquids similar to ignite or rekindle hot coals. Use only Mibrasa® ecofire firelighters.
- In the case of installing the Robotayaki in an outdoor setting, do not cover it with any type of protective cover or inflammable material when it is in operation or hot.
- Review the restrictions of point 4.1 on minimum distances from combustible materials.

## 8. General conditions

---

### 8.1. Warranty

- All Mibrasa® Robotayaki have a 2-year warranty against any manufacturing defect.
- The customer will be responsible for the installation, fine-tuning and maintenance of the goods.
- The warranty is void of:
  - (I) damage caused by misuse or poor product installation,
  - (II) where the buyer or third party has started repairs, modifications or adjustments without the prior consent of Mibrasa®,
  - (III) those defects not immediately notified within the warranty period stated above,
  - (IV) those defects or damage due to negligence not attributable to Mibrasa®, or an accident, misuse, improper installation, mishandling or abnormal conditions of temperature, humidity or dirt,
  - (VI) that have become damaged through no fault of Mibrasa®.

### 8.2. Returns

- All goods must be returned in the original condition.
- All returns must be notified in writing, and must be confirmed by our sales department.
- All returns must reach Mibrasa® prepaid. Returned material must enclose the invoice and delivery note number.
- Returns of goods will only be accepted in its original packaging, unused and in re-sellable condition. Returned goods that are used, obsolete or worn out will not be considered under warranty and a credit note will not be issued.
- For all returned goods, there will be a 10% fee of the refund amount to cover depreciation, demerit and administrative tasks.

### 8.3. Property Reserve

- Mibrasa® retains title to the goods to the total amount of the price integrity.
- Mibrasa® reserves the right to change their products and prices without notice.







# **MIBRASA®**

*Feeding the Senses!*

Factory, head office and showroom:

Polígon Pla de Sant Joan  
C/ Joan Rovira i Bastons, 26  
17230 Palamós (Girona) Spain

+34 972 601 942  
[www.mibrasa.com](http://www.mibrasa.com)  
[mibrasa@mibrasa.com](mailto:mibrasa@mibrasa.com)

v.1.5