

COMENDA *Prime*

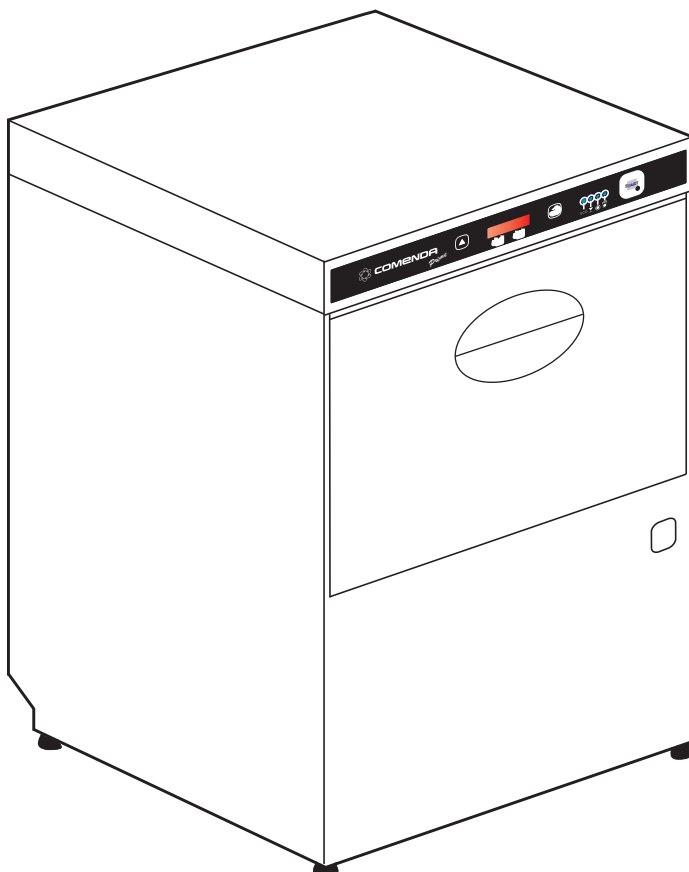

Use and maintenance instructions
Instructions pour l'utilisation et l'entretien
Bedienungs- und Wartungsanleitung
Instrucciones para el uso y el mantenimiento
Istruzioni per l'uso e la manutenzione



Ed. 03/2018

DICHIARAZIONE DI CONFORMITÀ CE
DECLARATION OF CONFORMITY CE
CE DECLARACION DE CONFORMIDAD
DECLARATION DE CONFORMITÉ CE
KONFORMITÄTSEKTLÄRUNG CE
CE CONFORMITEITSVERKLARING
CE KONFORMITETSERKLÆRING
CE DEKLARATION



Noi dichiariamo sotto la nostra esclusiva responsabilità che il prodotto:
The undersigned hereby declares under full responsibility that the following product:
Declaramos bajo nuestra responsabilidad que el producto:
Nous soussignées attestons sous notre entière responsabilité que le produit suivant:
Die unterzeichnete Fa. erklärt unter eigener Verantwortung, dass folgende Produkte:
Ondergetekende firma verklaart dat de:
Hermed erklæres at følgende produkter:
Härmed bekräftas att nedanstående produkt:

**LAVABICCHIERI – GLASSWASHER – LAVAVASOS – LAVE-VERRES – GLÄSERSPÜLER –
GLAZENSPOELMACHINE – GLASOPVASKEMASKINE – GLASDISKMASKIN**

PB24..., PB34...

in base a quanto previsto dalle Direttive CEE:
on the basis of what is foreseen by the Directives CEE:
en base a lo previsto en la directiva CEE:
selon ce qui est prévu par les Directives CEE:
aufgrund der vorgesehenen Richtlinien:
gebaseerd op de CE-richtlijnen:
iht. EU-direktiv:
enligt EU-direktiv:

2006/42/CE, 2014/35/CE, 2014/30/CE

al quale questa dichiarazione si riferisce, è conforme alle seguenti norme:
for which this declaration refers to in accordance to the following standards:
al que se refiere asta declaraciones de conformidad a las siguientes normas:
auquel se réfère cette déclaration, est conforme aux normes suivantes:
auf welche sich diese Erklärung bezieht, folgendem Standard entsprechen:
waarop deze verklaring betrekking heeft, volgens de standaard:
som er omfattet af denne erklæring, overholder følgende standarder:
som omfattas av denna deklaration motsvarar följande standard:

**EN 60335-1:2012+A11:2014, EN 60335-2-58:2005+A1:2008+A11:2010
EN 55014-1:2006+A1:2009+A2:2011, EN 55014-2:2015**

Decliniamo ogni responsabilità per sinistri a persone o a cose derivanti da manomissione da parte di terzi o da carenza di manutenzione o riparazione.
We decline any responsibility for injuries or damage derived from machine misuse, abuse by others or improper machine maintenance or repairs.
Declinamos toda responsabilidad por sinistros a personas por la incorrecta manipulación por parte de tercero e la carencia de mantenimiento o reparación.
Nous déclinons toute responsabilité pour sinistres à personnes ou à objet qui dérivent de l'intervention de la part de tiers non spécialistes ou de carences de maintenance ou réparation.
Wir lehnen jegliche Verantwortung für Schäden an Personen oder Dingen ab, die auf fehlerhaftes Eingreifen Dritter oder auf mangelhafte Wartung oder Reparatur zurückzuführen sind.
Wij zijn op geen enkele manier verantwoordelijk voor schade aan personen of materialen welke voortvloeien uit onoordeelkundig gebruik, reparatie dan onderhoud aan de machines door derden.
Vi frasiger os ethvert ansvar for skader opstået som følge af fejlagtig anvendelse af maskinen, misbrug, eller utilstrækkeligt vedligehold eller reparation.
Vi frantar oss allt ansvar for skador till följd av felaktig användning av maskinen, missbruk eller otillräckligt underhåll eller reparation.

Persona autorizzata a costituire il fascicolo tecnico.
Persona autorizzata a redigere la dichiarazione di conformità.
Person authorized to compile the technical file.
Person authorized to draw up the declaration of conformity.
Persona facultada para elaborar el expediente técnico.
Persona autorizada para expedir la declaración de conformidad.
Personne autorisée à constituer le dossier technique.
Personne habilitée à établir la déclaration de conformité.
Person, die bevollmächtigt, die technischen Unterlagen zusammenzustellen.
Person die Genehmigung zur Ausarbeitung der Konformitätserklärung.
Person die gemachtigd is het technisch dossier samen te stellen.
Person die gemachtigd is tot het opstellen van de verklaring van overeenstemming.
Person bemyndiget til at udarbejde det tekniske dossier.
Person bemyndiget til at udarbejde overensstemmelseserklæring.
Person som är behörig att sammanställa den tekniska dokumentationen.
Person som är behörig att upprätta en försäkran om överensstämmelse.

11/10/2017



Andrea Bertone
GENERAL MANAGER

**DICHIARAZIONE DI CONFORMITÀ CE
DECLARATION OF CONFORMITY CE
CE DECLARACION DE CONFORMIDAD
DECLARATION DE CONFORMITÉ CE
KONFORMITÄTSEKTLÄRUNG CE
CE CONFORMITEITSVERKLARING
CE KONFORMITETSERKLÆRING
CE DEKLARATION**

Noi dichiariamo sotto la nostra esclusiva responsabilità che il prodotto:

The undersigned hereby declares under full responsibility that the following product:

Declaramos bajo nuestra responsabilidad que el producto:

Nous soussignées attestons sous notre entière responsabilité que le produit suivant:

Die unterzeichnete Fa. erklärt unter eigener Verantwortung, dass folgende Produkte:

Ondergetekende firma verklaart dat de:

Hermed erklæres at følgende produkter:

Härmed bekräftas att nedanstående produkt:

**LAVASTOVIGLIE – DISHWASHER – LAVAVAJILLAS – LAVE-VASSEILLE – GESCHIRRSPÜLER –
VAATWASMACHINE – TALLERKENOPVASKEMASKINE – UNDERBANKDISKMASKIN****PF45..., PF46...,**

in base a quanto previsto dalle Direttive CEE:

on the basis of what is foreseen by the Directives CEE:

en base a lo previsto en la directiva CEE:

selon ce qui est prévu par les Directives CEE:

aufgrund der vorgesehenen Richtlinien:

gebaseerd op de CE-richtlijnen:

iht. EU-direktiv:

enligt EU-direktiv:

2006/42/CE, 2014/35/CE, 2014/30/CE

al quale questa dichiarazione si riferisce, è conforme alle seguenti norme:

for which this declaration refers to in accordance to the following standards:

al que se refiere esta declaración de conformidad a las siguientes normas:

auquel se réfère cette déclaration, est conforme aux normes suivantes:

auf welche sich diese Erklärung bezieht, folgendem Standard entsprechen:

waarop deze verklaring betrekking heeft, volgens de standaard:

som er omfattet af denne erklæring, overholder følgende standarder:

som omfattas av denna deklaration motsvarar följande standard:

**EN 60335-1:2012+A11:2014, EN 60335-2-58:2005+A1:2008+A11:2010
EN 55014-1:2006+A1:2009+A2:2011, EN 55014-2:2015**

Decliniamo ogni responsabilità per sinistri a persone o a cose derivanti da manomissione da parte di terzi o da carenza di manutenzione o riparazione.

We decline any responsibility for injuries or damage derived from machine misuse, abuse by others or improper machine maintenance or repairs.

Declinamos toda responsabilidad por sinistros a personas o a cosas por la incorrecta manipulación por parte de tercero o la carencia de mantenimiento o reparación.

Nous déclinons toute responsabilité pour sinistres à personnes ou à objets qui dérivent de l'intervention de la part de tiers non spécialistes ou de carences de maintenance ou réparation.

Wir lehnen jegliche Verantwortung für Schäden an Personen oder Dingen ab, die auf fehlerhaftes Eingreifen Dritter oder auf mangelhafte Wartung oder Reparatur zurückzuführen sind.

Wij zijn op geen enkele manier verantwoordelijk voor schade aan personen of materialen welke voortvloeien uit onoordeelkundig gebruik, reparatie dan onderhoud aan de machines door derden.

Vi frasiger os ethvert ansvar for skader opstået som følge af fejlagtig anvendelse af maskinen, misbrug, eller utilstrækkeligt vedligehold eller reparation.

Vi frantar oss allt ansvar för skador till följd av felaktig användning av maskinen, missbruk eller otillräckligt underhåll eller reparation.

Persona autorizzata a costituire il fascicolo tecnico.

Persona autorizzata a redigere la dichiarazione di conformità.

Person authorized to compile the technical file.

Person authorized to draw up the declaration of conformity.

Persona facultada para elaborar el expediente técnico.

Persona autorizada para expedir la declaración de conformidad.

Personne autorisée à constituer le dossier technique.

Personne habilitée à établir la déclaration de conformité.

Person, die bevollmächtigt, die technischen Unterlagen zusammenzustellen.

Person die Genehmigung zur Ausarbeitung der Konformitätserklärung.

Person die gemachtigd is het technisch dossier samen te stellen.

Person die gemachtigd is tot het opstellen van de verklaring van overeenstemming.

Person bemyndiget til at udarbejde det tekniske dossier.

Person bemyndiget til at udarbejde overensstemmelseserklæring.

Person som är behörig att sammanställa den tekniska dokumentationen.

Person som är behörig att upprätta en försäkran om överensstämmelse.

11/10/2017**Andrea Bertone
GENERAL MANAGER**

Space left blank intentionally

Espace laissé en blanc intentionnellement

Absichtlich leer gelassener Freiraum

Espacio dejado en blanco intencionalmente

Spazio lasciato bianco intenzionalmente

DISHWASHER
LAVE-VAISSELLE - SPÜLMASCHINE
LAVAVAJILLAS - LAVASTOVIGLIE

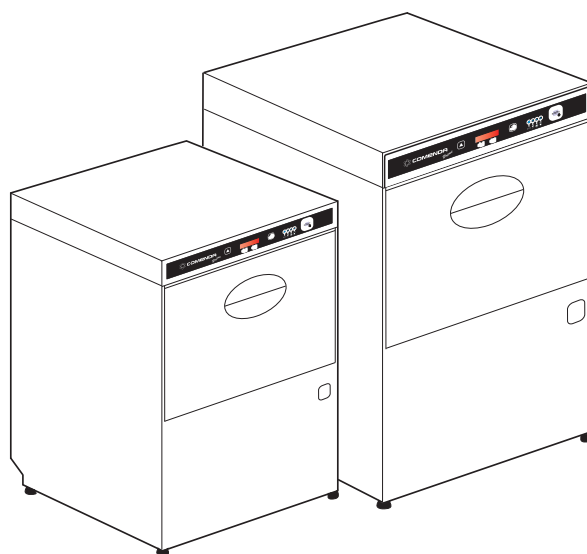

mod.

PB 24

PB 34

PF 45

PF 46

The figures related to the instructions are shown on the last pages.
Les figures relatives aux instructions se trouvent aux dernières pages.
Die Abbildungen zu den Anweisungen befinden sich auf den letzten Seiten.
Las figuras correspondientes a las instrucciones se encuentran en las últimas páginas.
Le figure relative alle istruzioni sono riportate sulle ultime pagine.

EN.....INFORMATION FOR USERS

Pursuant to Directive 2012/19/EU on waste electrical and electronic equipment (WEEE)

The crossed-out “wheelie-bin” symbol on the dishwasher’s serial number plate indicates that the product must be collected separately from other waste at the end of its useful life.

The separate collection of the dishwasher, at the end of its life, is organised and managed by the manufacturer.

A user who wishes to dispose of this equipment must therefore contact the manufacturer and follow the system adopted by the latter to allow the equipment to be collected separately at the end of its life.

Adequate separate collection of the dishwasher for the subsequent start-up after being disposed of for recycling, treatment and environmentally friendly disposal helps avoid possible adverse effects on the environment and health and favours the reuse and/or recycling of the materials, which the equipment is composed of.

The unauthorised disposal of the product by the holder leads to administrative sanctions being applied according to the current laws.

FR.....INFORMATION AUX UTILISATEURS

Aux termes de la Directive 2012/19/EU relative aux déchets d'équipements électriques et électroniques (DEEE)

Le symbole de la poubelle barrée reporté sur la plaque d'identification du lave-vaisselle indique que le produit doit être éliminé, à la fin de sa durée de vie utile, séparément des autres déchets.

Le tri sélectif du lave-vaisselle arrivé en fin de vie est organisé et géré par le fabricant.

L'utilisateur qui souhaite se débarrasser de cet appareil devra donc contacter le fabricant et suivre le système que celui-ci a adopté pour permettre le tri sélectif de l'appareil à sa fin de vie.

Le tri sélectif approprié pour l'envoi du lave-vaisselle au recyclage, au traitement et à l'élimination compatible avec l'environnement, contribue à éviter tout effet nocif pour l'environnement et pour la santé, et favorise la ré-utilisation et/ou le recyclage des matériaux qui composent l'appareil.

L'élimination abusive du produit de la part du détenteur entraîne l'application des sanctions administratives prévues par la réglementation en vigueur.

DE.....INFORMATIONEN FÜR DIE BENUTZER

Gemäß der Richtlinie 2012/19/EU über die Entsorgung von Elektro- und Elektronik-Altgeräten (WEEE)

Das Symbol mit der durchgestrichenen Mülltonne auf dem Typenschild des Geschirrspülers zeigt an, dass das Produkt am Ende seiner Lebensdauer getrennt von anderen Abfällen entsorgt werden muss.

Das Recycling des Geschirrspülers am Ende seiner Lebensdauer wird vom Hersteller organisiert und verwaltet.

Der Benutzer, der dieses Gerät entsorgen möchte, sollte daher den Hersteller kontaktieren und das System befolgen, das dieser vorsieht, um am Ende der Lebensdauer die getrennte Entsorgung des Gerätes zu ermöglichen.

Die angemessene Trennung und die nachfolgende Übergabe der außer Betrieb genommenen Spülmaschine an eine Stelle für das Recycling oder die umweltgerechte Entsorgung trägt dazu bei, eventuelle negative Auswirkungen auf die Umwelt und auf die Gesundheit zu verhindern, und fördert die Wiederverwendung und/oder Wiederverwertung der Materialien, aus denen das Produkt hergestellt ist.

Die illegale Entsorgung des Produkts durch den Eigentümer führt zur Anwendung von gesetzlich vorgesehenen verwaltungsrechtlichen Sanktionen.

ES.....INFORMACIÓN PARA LOS USUARIOS

De acuerdo con la Directiva 2012/19/EU sobre residuos de aparatos eléctricos y electrónicos (RAEE)

El símbolo del contenedor tachado que aparece en la placa de la matrícula del lavavajillas indica que el producto al final de su vida útil se debe recoger separado de los otros desechos.

La recogida selectiva del lavavajillas cuando llega al final de su vida útil la organiza y gestiona el productor.

El usuario que quiera deshacerse de este equipo debe ponerse en contacto con el productor y seguir el sistema que este ha adoptado para permitir la recogida selectiva del equipo al final de su vida útil.

La adecuada recogida selectiva para el posterior envío del lavavajillas al reciclaje, tratamiento y eliminación compatible con el medio ambiente, contribuye a evitar posibles efectos negativos sobre el medio ambiente y la salud, y favorece la reutilización y/o el reciclaje de los materiales que componen el equipo.

La eliminación ilegal del producto por parte del propietario conlleva la aplicación de las sanciones administrativas establecidas por la normativa vigente.

IT.....INFORMAZIONE AGLI UTENTI

Ai sensi della Direttiva 2012/19/EU relativa ai rifiuti di apparecchiature elettriche ed elettroniche (RAEE)

Il simbolo del cassonetto barrato riportato sulla targhetta matricola della lavastoviglie indica che il prodotto alla fine della propria vita utile deve essere raccolto separatamente dagli altri rifiuti.

La raccolta differenziata della lavastoviglie giunta a fine vita è organizzata e gestita dal produttore.

L'utente che vorrà disfarsi della presente apparecchiatura dovrà quindi contattare il produttore e seguire il sistema che questo ha adottato per consentire la raccolta separata dell'apparecchiatura giunta a fine vita.

L'adeguata raccolta differenziata per l'avvio successivo della lavastoviglie dimessa al riciclaggio, al trattamento e allo smaltimento compatibile a livello ambientale, contribuisce ad evitare possibili effetti negativi sull'ambiente e sulla salute e favorisce il reimpiego e/o riciclo dei materiali di cui è composta l'apparecchiatura.

Lo smaltimento abusivo del prodotto da parte del detentore comporta l'applicazione delle sanzioni amministrative previste dalla normativa vigente.

EN**WARNING**

Read this manual carefully before proceeding with the installation, commissioning, adjustment and maintenance operations of the dishwasher Mod. PB-PF.

In the event of a machine fault or malfunction, contact only an authorised technical centre or COMENDA Ali Group Srl directly.

FR**MISE EN GARDE**

Avant de procéder à l'installation, à la mise en service, au réglage et aux opérations d'entretien du lave-vaisselle Mod. HB-HF, lire ce manuel avec attention.

En cas de panne ou de mauvais fonctionnement de la machine, s'adresser exclusivement au centre technique agréé ou directement à l'entreprise COMENDA Ali Group Srl.

DE**HINWEIS**

Vor der Installation, Inbetriebnahme, Einstellung und Wartung der Geschirrspülmaschine Mod. PB-PF muss das vorliegende Handbuch aufmerksam gelesen werden.

Im Falle von Störungen oder unzuverlässigem Betrieb der Maschine wenden Sie sich ausschließlich an ein autorisiertes Kundendienstzentrum oder direkt an den Hersteller COMENDA Ali Group Srl.

ES**ADVERTENCIA**

Antes de realizar la instalación, la puesta en funcionamiento, la regulación y las operaciones de mantenimiento del lavavajillas Mod. PB-PF, lea atentamente el presente manual.

En caso de avería o problema de funcionamiento del equipo contacte solo con un centro técnico autorizado o directamente con la empresa COMENDA Ali Group Srl.

IT**AVVERTENZA**

Prima di procedere all'installazione, alla messa in funzione, alla regolazione e alle operazioni di manutenzione della lavastoviglie Mod. PB-PF, leggere attentamente il presente manuale.

In caso di guasto o cattivo funzionamento della macchina rivolgersi esclusivamente ad un centro tecnico autorizzato o direttamente alla ditta COMENDA Ali Group Srl

The manufacturer reserves the right to make changes that will be useful to their products without compromising their essential characteristics.

La société constructrice se réserve le droit d'apporter des modifications utiles à ses produits sans compromettre les caractéristiques essentielles.

Der Hersteller behält sich das Recht vor, Änderungen anzubringen, die für seine Produkte nützlich sind, ohne ihre wesentlichen Eigenschaften zu beeinträchtigen.

El fabricante se reserva el derecho de realizar cambios que considere útiles para sus productos sin perjudicar sus características esenciales.

La ditta costruttrice si riserva il diritto di apportare modifiche che si renderanno utili ai propri prodotti senza comprometterne le caratteristiche essenziali.

<p style="text-align: center;">CONTENTS INDEX - INHALT - ÍNDICE - INDICE</p>
--

WEEE pag. 4
DEEE
RAEE

Warning pag. 5
Mise en garde
Hinweis
Advertencia
Avvertenza

Overall dimensions pag. 7
Dimensions d'encombremen
Abmessungen
Dimensiones totales
Dimensioni d'ingombro

Technical data pag. 8
Données techniques
Technische Daten
Datos técnicos
Dati tecnici

Description of the commands pag. 9
Description des commandes
Beschreibung Steuerungen
Descripción de los mandos
Descrizione comandi

ENGLISH Page 11

FRANÇAIS Page 29

DEUTSCH Seite 47

ESPAÑOL Página 65

ITALIANO Pagina 83



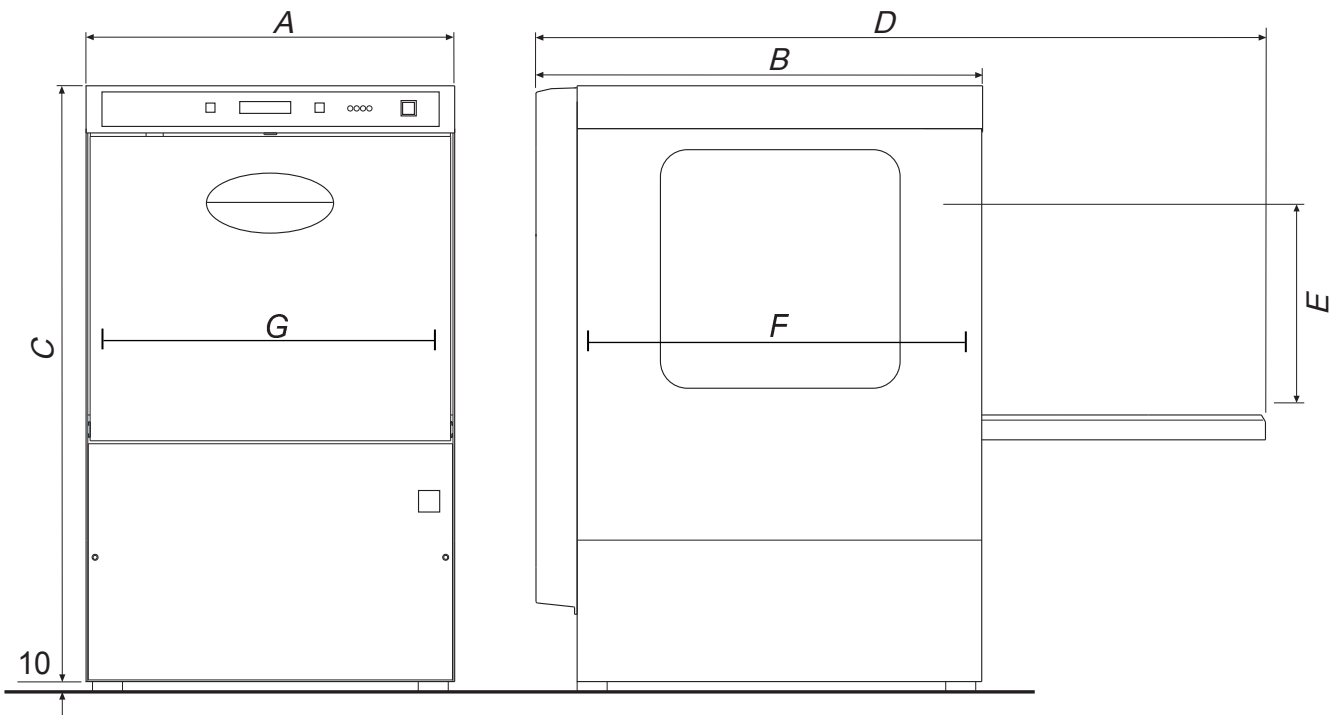

OVERALL DIMENSIONS
ABMESSUNGEN - DIMENSIONES TOTALI - DIMENSIONI DI INGOMBRO



<i>Model Modèle Modell</i> <i>Modelo Modello</i>	A (mm)	B (mm)	C (mm)	D (mm)	E (mm)	F (mm)	G (mm)
PB24	460	521	618	791	220		
PB24 A	460	521	618	791	220		
PB34	460	521	680	851	270		
PB34 A	460	521	680	851	270		
PF45	600	626	825	1005	360		
PF45-R	600	626	825	1005	360		
PF45-RA	600	626	825	1005	360		
PF46	600	695	830	1150	400	615	500
PF46-R	600	695	830	1150	400	615	500

**TECHNICAL DATA - DONNÉES TECHNIQUES
TECHNISCHE DATEN - DATOS TÉCNICOS - DATI TECNICI**

	<i>Dish rack production/hour</i> Production paniers/heure Produktion Körbe/h Producción cestas/hora Produzione cestell/ora	<i>Electrical connection</i> Branchement électrique Elektrischer Anschluss Conexión eléctrica Allacciamento elettrico	<i>Total power</i> Puissance totale Gesamtleistung Potencia total Potenza totale	<i>Boiler heating element</i> Résistance chauffe-eau Widerstand Boiler Resistencia calentador Resistenza boiler	<i>Tank heating element</i> Résistance cuve Widerstand Wanne Resistencia cuba Resistenza vasca	<i>Washing pump</i> Pompe lavage Spülpumpe Bomba de lavado Pompa lavaggio
PB24	40/40/30/15	230V ~ 50/60Hz	2,66 kW	2,4 kW	2 kW	0,26 kW
PB34	40/40/30/15	230V ~ 50/60Hz	2,66 kW	2,4 kW	2 kW	0,26 kW
PF45	40/40/30/15	230V ~ 50/60Hz	5,45kW	5 kW	2 kW	0,45 kW
	40/40/30/15	400V3N ~ 50/60Hz	5,45/7,45kW	5/7 kW	2 kW	0,45 kW
PF46	40/40/30/15	400V3N ~ 50/60Hz	7,83kW	7 kW	2 kW	0,83 kW

	<i>Tank capacity</i> Capacité cuve Fassungsvermögen Wanne Capacidad de la cuba Capacità vasca	<i>Boiler capacity</i> Capacité chauffe-eau Fassungsvermögen Boiler Capacidad del calentador Capacità boiler	<i>Water cons. per cycle</i> Cons. eau par cycle Wasserverbr. pro Zyklus Cons. agua por ciclo Cons. acqua x ciclo	<i>Cycle duration - Durée cycle</i> <i>Zyklusdauer - Duración del ciclo - Durata ciclo</i>			
				ECO ECO ECO ECO ECO (RAPID) (RAPIDE) (SCHNELL) (RÁPIDO) (RAPIDO)	GLASSES VERRES GLÄSER VASOS BICCHIERI	DISHES PLATS GESCHIRR PLATOS PIATTI	INTENSIVE INTENSIF INTENSIV INTENSIVO INTENSIVO
PB24	12 l	4 l	2,5 l				
PB34	12 l	4 l	2,5 l		(DIN10511)	(DIN10510)	
PF45	21 l	7,5 l	2,5 l				
PF46	23 l	7,5 l	3,5 l				

	<i>Drain fitting</i> Raccord d'évacuation Auslassfiting Empalme de descarga Raccordo di scarico	<i>Storage and operating temp.</i> Temp. de fonctionnement et stockage Belr- u. Lagerungstemp. Temp. func. y almacén. Temper. di funz. e stocc.	<i>Relative humidity</i> Humidité relative Relative Feuchtigkeit Humedad relativa Umidità relativa	<i>Washing temperature</i> Température lavage Spültemperatur Temperatura de lavado Temperatura lavaggio	<i>Rinse temperature</i> Température rinçage Nachspültemperatur Temperatura de enjuague Temperatura risciacquo
PB24	ø 28 mm	5° ÷ 40° C	20 ÷ 90 %	50° ÷ 60° C	80° ÷ 90° C
PB34	ø 28 mm	5° ÷ 40° C	20 ÷ 90 %	50° ÷ 60° C	80° ÷ 90° C
PF45	ø 31 mm	5° ÷ 40° C	20 ÷ 90 %	50° ÷ 60° C	80° ÷ 90° C
PF46	ø 31 mm	5° ÷ 40° C	20 ÷ 90 %	50° ÷ 60° C	80° ÷ 90° C

	<i>Water inlet max temp.</i> Temp. max entrée eau Nachspültemperatur Temp. máx. entrada agua Temp. max entrata acqua	<i>Sound pressure level</i> Niveau pression acous. Geräuschpegel Nivel de presión acús. Livello pressione acus.	<i>Dish rack dimensions</i> Dimensions panier Abmessungen Korb Dimensiones cesta Dimensioni cestello	<i>Net weight</i> Poids net Nettogewicht Peso neto Peso netto	<i>Pack. machine weight</i> Poids machine emball. Gewicht verpackte Maschine Peso máquina embal. Peso macchina imball.	<i>Water supply</i> Alimentation hydrique Wasserversorgung Alimentación hidráulica Alimentazione idrica
PB24	55° C	< 70 dB (A)	400 x 400 mm	36 kg	41 kg	2÷4 bar Ø 3/4" G
PB34	55° C	< 70 dB (A)	400 x 400 mm	37 kg	43 kg	2÷4 bar Ø 3/4" G
PF45	55° C	< 70 dB (A)	500 x 500 mm	58 kg	66 kg	2÷4 bar Ø 3/4" G
PF46	55° C	< 70 dB (A)	500 x 600 mm	66 kg	74 kg	2÷4 bar Ø 3/4" G

CONTROL PANEL - TABLEAU DE BORD DES COMMANDES
 BEDIENBLENDE - PANEL DE CONTROL - CRUSCOTTO COMANDI

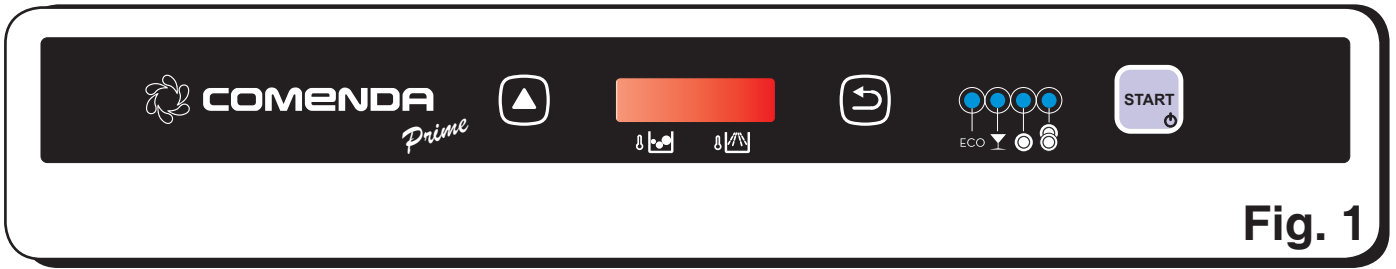

















Fig. 1









-  **ON/OFF**
Start selected cycle
-  **Allumage/Arrêt (ON/OFF)**
Démarrage du cycle sélectionné
-  **Ein-/Ausschalten (ON/OFF)**
Start des gewählten Zyklus
-  **Encendido/Apagado (ON/OFF)**
Puesta en marcha del ciclo seleccionado
-  **Accensione/Spegnimento (ON/OFF)**
Avvio ciclo selezionato









-  **Scroll/Selection Key**
-  **Touche Défilement/Sélection**
-  **Scroll-/Auswahl taste**
-  **Tecla Desplazamiento/Selección**
-  **Tasto Scorrimento/Selezione**

-  **BACK key**
-  **Touche BACK**
-  **BACK-Taste**
-  **Tecla BACK**
-  **Tasto BACK**



-  **Display**
-  **Écran**
-  **Display**
-  **Display**
-  **Display**

Space left blank intentionally
Espace laissé en blanc intentionnellement
Absichtlich leer gelassener Freiraum
Espacio dejado en blanco intencionalmente
Spazio lasciato bianco intenzionalmente

ENGLISH

Part 1: Use and safety description

Part 2: Reserved for Operator

**Part 3: Reserved for the Authorised and
Qualified Technician**

ENGLISH

SPECIAL WARNINGS FOR THE OPERATOR

- Before commissioning the machine, the operator must have carefully read this publication and acquired in-depth knowledge of the technical specifications and the machine controls.
- Before installing the machine, check that the installation site is compatible with its overall dimensions.
- **If the machine is “recessed”, make sure that the compartment and adjacent furnishing elements are suitable, namely that they do not suffer from being exposed to the water vapour which can escape the machine during operation and especially when the door opens after a wash cycle.**
- When installing or removing part of the machine, use only suitable lifting and handling equipment for its weight.
- Do not allow unauthorised and unqualified personnel to start, adjust, run or repair the machine. Furthermore, refer to this manual for the necessary operations.
- The mechanical parts and the electric/electronic components inside the machine are protected by fully closed panels.
- Before cleaning and/or servicing the machine, **make sure that the main switch is set to “OFF” O**, in order to disconnect power from the machine while the operator is intervening.
- The electric power system must be provided with an automatic triggering device upstream of the main switch of the machine and a suitable earthing system which complies with all the requirements of industrial accident-prevention standards.
- If the need arises to intervene on the main switch or in its vicinity, disconnect the power to the line which the main switch is connected to.
- All inspections and maintenance operations which require the safety guards to be removed must be carried out under the full responsibility of the user.
It is therefore recommended that only specialised and authorised technical personnel perform these operations.
- Check that all the accident prevention safety devices (barriers, guards, casings, microswitches, etc.) are not tampered with and are in perfect working order before operation. If not, have them repaired.
- **Do not remove the safety devices.**
- To avoid personal risks, use only electrical tools which are correctly connected to the earth socket and compliant with national safety regulations.
- Do not tamper with the electrical system or with any other mechanism for any reason whatsoever.
- **Never use your hands** or unsuitable instruments to locate leaks from the various hoses. Pressurised or irritating air and fluids could cause serious harm to persons and/or objects.
- Do not use your hands instead of suitable tools to operate the machine
- Do not stop moving parts with your hands or other objects
- **PAY THE UTMOST ATTENTION TO THE RATING PLATES ON THE MACHINE WHENEVER OPERATING ON IT OR IN ITS VICINITY.**
- The user must keep all the rating plates legible.
- Do not climb onto the door or on top of the machine.
- The user must also replace all rating plates which for any reason have deteriorated or are not clearly visible, requesting new ones from the Spare Parts Service.
- In case of machine malfunctioning or damage to its components, contact the maintenance manager without performing any further repairs.
- It is strictly prohibited for anyone to use the machine for purposes other than those specifically intended and documented.
The machine must always be used in the ways, times and places foreseen by good practice standards, by current laws in every country, even though the specific country may not have appropriate standards that regulate the sector.
- **The manufacturer will not be held liable for accidents or harm to persons or objects resulting from failure to comply with the safety requirements and standards indicated herein.**
- **These requirements, together with standards relative to machine installation and to electrical connections, constitute an integral part of the Industrial Accident Prevention Regulations of each individual country.**
- **THESE SAFETY STANDARDS INTEGRATE AND DO NOT REPLACE LOCAL SAFETY STANDARDS IN FORCE**
- **NEVER have rushed or makeshift repairs carried out which could jeopardise proper machine operation.**
- **WHEN IN DOUBT, ALWAYS REQUEST THE INTERVENTION OF SPECIALISED PERSONNEL.**
- **ANY TAMPERING BY THE USER RELIEVES THE MANUFACTURER FROM ALL LIABILITY AND MAKES THE USER SOLELY RESPONSIBLE FOR RESPONDING TO THE COMPETENT ACCIDENT PREVENTION AUTHORITIES.**
- **This appliance is not intended to be used by persons (including children) with reduced physical, sensory or mental capabilities, or lack of experience and knowledge, unless they have been given supervision or instruction concerning use of the appliance by a person responsible for their safety.**
- **Make sure that children do not play with the appliance.**
- **It is prohibited to spray water on the appliance to clean it.**

1.1 GENERAL DESCRIPTION

Single stainless steel wall construction. Counterbalanced double wall moulded door. Moulded tank bottom with multiple filtering (collection filter and micro-filter). Incorporated rinse agent dispenser. Connection set-up of the detergent dispenser.

Multifunction and multi-colour START button. 4 preset cycles (ECO/GLASSES/PLATES/INTENSIVE) with customisable duration and temperatures. Temperature display (wash and rinse). Cycle progress status indications. Alarm diagnostics.

Optional: drain pump and stainless steel washing arms.

1.2 TYPE OF USE AND CONTRAINDICATIONS

The machines were designed and built to wash dishes in specific dish racks, using detergent and rinse agent.

- Objects allowed: glasses, mugs, cups, saucers, cutlery, inserted in specific dish racks, made of suitable material for dishwashers and small enough for the dish rack and machine.
- All specific detergents and rinse agents for industrial dishwashers normally found on the market may be used.

ATTENTION

Any improper use of the machine relieves the manufacturer from all liability for accidents to objects or persons and terminates any warranty conditions.

1.3 TRANSPORT, SHIPPING and STORAGE (Fig. 2)

- The machine is normally shipped inside a cardboard box secured with straps.
- Use a forklift truck or pallet truck to transport the packed machine, placing the box on the relative forks.

ATTENTION

The machine must only be shipped and stored sheltered against atmospheric agents.

1.4 CHECKS UPON RECEIPT

When the supply is received, check that the packages are intact and visually not damaged.

If all is intact, remove the packaging (unless different instructions are given by the manufacturer) and check that the machine has not been damaged during transportation.

Check for any structural damage, crushing or breakage.

If any damage or imperfections are found:

- 1- Immediately notify the carrier either by telephone or through registered mail with acknowledgment of receipt;

- 2- Inform the manufacturer prior to registered mail with acknowledgment of receipt.

IMPORTANT

Any damage or faults must be promptly reported and in any case **within 3 days** from the data of receipt of the machine.

1.5 UNPACKING (Fig. 2-3-4)

Proceed as follows to remove the machine from the packaging:

1. Remove the straps (1) securing the box.
2. Remove the box (2), lifting it upwards.
3. Remove the protective film from the machine.
4. Remove the machine from the base, lifting it from the bottom of the body (Fig. 4).
5. All packaging elements must be collected and not left in the reach of children as they are sources of danger. They must be disposed of as solid urban waste.

ATTENTION

Once the machine has been unpacked, **NEVER** lift it from the electric components box.

Lift the machine from the bottom of the body. Place it on the forks of the forklift truck to transport it.

1.6 MACHINE IDENTIFICATION (Fig. 5)

- The serial number and relative machine data are written on the rating plate (3) on the right side of the machine.

IMPORTANT

To request technical support or to order spare parts, always include the model and serial number of the machine.

1.7 DESCRIPTION OF THE SAFETY DEVICES

- The **PB-PF** models are equipped with a safety micro-switch which blocks the wash pump when the tank door is opened accidentally.
- Electric parts closed by panels secured with screws.
- Electric equipotential earth electrode.
- Safety overflow (14) Fig.9 to prevent water from overflowing.

1.8 REGULATORY REFERENCES

- The machine and its safety devices are built in compliance with the following standards:
- Essential safety requirements set forth by directives 2006/42/EEC (MD), 2014/35/EEC (LVD), 2014/30/EEC (EMC).
- Requirements set forth by directive 2002/95/EEC (RoHS).

2.1 PB-PF OPERATION

2.1.a Switch-on and Preparing the machine (Fig. 1)

To turn the machine on, keep the START (ON/OFF) key pressed for about 5 sec.

The START key turns YELLOW.

F2 appears on the display.



IMPORTANT

The last cycle used remains set and is displayed when the machine is switched on.

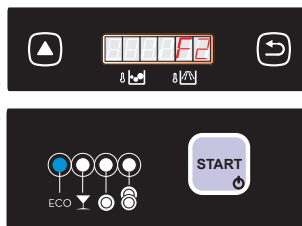

When the water level is reached in the tank, the START key FLASHES GREEN.



The set-point temperatures appear on the display.



The machine is already available for washing in this condition.

If the wash cycle is started with the FLASHING GREEN key, the START key will turn RED and H3 will appear on the right side of the display.

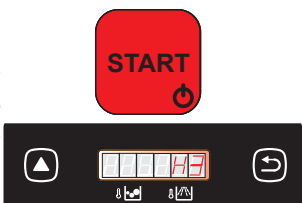

When the set tank temperature is reached, the START key lights up STEADY GREEN.



TEMPERATURE READINGS

The set-point temperatures of the water in the tank and boiler appear on the display.



With the machine in stand-by, the ACTUAL temperature in the boiler and in the tank for the selected cycle can be displayed by pressing the BACK key.

If no key is pressed, after about 5 sec., the set-point temperatures appear on the display again.



WASH OPERATIONS

Add the amount of industrial detergent into the tank, as recommended by the manufacturer, indicated on the product tank as a concentration in g/l.

Add an amount (in g/l) according to an average water consumption of 3l with every wash.

The volume of water in the tank, which is necessary for the amount of detergent to be calculated for models **PB-PF**, is indicated on the page related to the technical data of the dishwasher.

The rinse agent dosage is managed both during the fill-up phase and during the restoring phase by means of a hydraulic pump. The hydraulic pump is calibrated by a qualified technician during installation.

With each wash, the pump restores the values of the rinse agent indicated by the manufacturer.

We recommend installing a peristaltic pump to dose the detergent.

ATTENTION

When the items to be washed have burnt deposits or much time has passed before being washed, they must be soaked in water with an appropriate emollient product. Do not use manual washing products as they could generate foam inside the machine.

Introduce the dish rack into the machine after having removed solid waste from the objects to be washed.

2.1.b CYCLE SELECTION

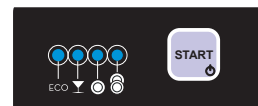

The duration of the wash cycle can be chosen from different cycle times, indicated by the respective symbol:



ECO



GLASSES



DISHES



INTENSIVE

selected by pressing the SCROLL key.



Every time the key is pressed, the cycle to be performed is displayed and the relevant BLUE LED lights up.

EXTRA CYCLE FUNCTIONS

- C1 (SELF-WASHING)
- C2 (DRAIN) optional
- C3 (REGENERATE) for versions A

2.1.c STARTING the WASH CYCLE

ATTENTION

It is recommended to check the level of detergent and rinse agent daily.

IMPORTANT

The **MANUAL** or **AUTOMATIC** (by closing the door) cycle start-up mode must be changed by an authorised technician.

STARTING the MANUAL WASH CYCLE

Press the **START** key to start the wash cycle.



The **START** key turns **BLUE** during the entire duration of the wash cycle. The countdown of the cycle appears on the display in seconds. Any other alarm messages will be displayed on the right. The following phases are performed during a complete cycle:

- WASH
- PAUSE
- RINSE
- DRAIN

During the cycle you can display the **ACTUAL** temperature by pressing the **BACK** key.



THERMOSTOP FUNCTION

If the rinsing temperature is not **ADEQUATE** at the end of the washing phase, the **COUNTDOWN** on the display stops, so as to indicate the intervention of the thermostat. The washing phase will last for as long as is necessary to reach the **MINIMUM GUARANTEED RINSE** temperature, equal to the value: $T^{\circ}\text{setpoint} - \text{set thermostat value}$. Once the set temperature value is reached, the countdown resumes until the cycle is completed.



Any other messages will be displayed on the right.

The pause to reach the ideal temperature can be prolonged to a maximum of **8 minutes**. After this time, the washing and rinsing cycle is completed and the **H1** alarm will appear on the right side of the display.



During the thermostat you can display the **ACTUAL** temperature by pressing the **BACK** key.



2.1.d INTERRUPTING the CYCLE

The wash cycle can be temporarily interrupted in two ways:

1) **F1** appears on the display when the door is opened. When the door is closed again, the cycle resumes from where it stopped.



Once the wash cycle is completed, the **SET** temperatures appear on the display. The **START** key turns **STEADY GREEN** (indicating that the machine is ready for the next cycle).



At the end of the wash cycle, remove the dish rack and shake it gently to remove the last drops on the washed items.

Let the objects dry and remove them from the dish rack with clean hands. Set everything on hygienic and stable surfaces.

2) Turn off the machine by keeping the **START** key pressed for 5 sec.



This way, every active cycle is interrupted definitely and the machine is set to **OFF**.

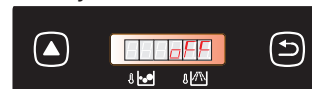

When switched on again, the LED associated with the last selected cycle will light up and the display will indicate the alarm code **"A1"** that will disappear when a new cycle begins.



2.1.e DRAINING WATER FROM THE TANK

2.1.e .1 MACHINE DRAIN without a DRAIN PUMP

The water in the tank can be emptied at any time of the day depending on the accumulated filth. Proceed as follows to perform this operation:



- **SWITCH OFF** the dishwasher by pressing the **START** key for 5 sec.

- **OFF** appears on the display.



- Release the overflow by turning it anti-clockwise (14), allowing the water to drain completely from the tank;

- Extract the tank filter (15) and clean it.

At the end of the cycle, put the filter (15) and the overflow (14) back into the respective seats.

2.1.e.2 DRAINING WATER FROM THE TANK for MACHINES with a DRAIN PUMP

The tank can be emptied by starting the manual drain cycle during which only the drain pump keeps running.

IMPORTANT

The execution of the cycle must start with the dishwasher ON, FULL TANK and DOOR CLOSED.

To DRAIN, you must:

Press the SCROLL key.

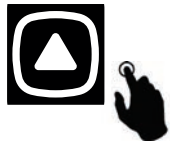

Select the **C2** function on the display.



Press the START key.



Open the door, release the overflow by turning it anti-clockwise (14) and close the door again.



The START key turns BLUE during the entire duration of the cycle.

The DRAIN CYCLE starts for the set time.

When the cycle is started, the left side of the display will show the countdown in seconds and the right side will display **C2**.

At the end of the cycle, the machine switches off automatically and the display reads OFF.



Pressing the START key with the DRAIN cycle in progress, the cycle is immediately interrupted, the dishwasher is switched off and OFF appears on the display.



ATTENTION

If the tank is not drained, the alarm **A10** will appear on the display at the end of the cycle.



2.1.f SELF-WASHING (and DRAIN)

A SELF-WASHING (and DRAIN) cycle can be carried out at the end of the day.

IMPORTANT

The execution of the cycle must start with the dishwasher ON, FULL TANK and DOOR CLOSED.

To perform the SELF-WASHING cycle, you must:

Press the SCROLL key.



Select the **C1** function on the display.



Press the START key.



Open the DOOR, release the overflow by turning it anti-clockwise and CLOSE the door again.

The START key turns BLUE during the entire duration of the cycle.



When the cycle is started, the left side of the display will show the countdown in seconds and the right side will display **C1**.

At the end of the SELF-WASHING cycle, the machine will have drained the water from the tank and OFF will appear on the display.



Pressing the START key with the SELF-WASHING and DRAIN cycle in progress, the cycle is immediately interrupted, the dishwasher is switched off and OFF appears on the display.



ATTENTION

If the tank is not drained, the alarm **A10** will appear on the display at the end of the cycle.



2.1.g SWITCHING OFF THE MACHINE AT THE END OF THE DAY

At the end of the working day, switch the machine off by pressing the START key for 5 sec. and wait for OFF to appear on the display.

Then, open the door, release the overflow by turning it anti-clockwise and close the door again.

**FOR MACHINES EQUIPPED WITH a DRAIN PUMP**

For machines fitted with a drain pump, press the START key for 5 sec. to **ACTIVATE** a 10-second countdown, during which the door must be opened, the overflow released by turning it anti-clockwise (14) and the door closed again. Then, the draining phase begins, shown on the display by means of a countdown on the left and the message **C2** on the right.



The drain can be interrupted at any time by pressing the START key once.

⚠ Disengage the wall-mounted main switch and close the water supply valves.

WARNINGS DURING OPERATION

- 1) Check that the washing temperature remains approximately 55-60° C;
- 2) Do not immerse your bare hands in the soapy water; should this happen, immediately rinse them with plenty of running water;
- 3) Use only specific anti-foaming detergents for industrial machines;
- 4) Deactivate the appliance in case of failure or malfunctioning.
For any repairs, contact a technical service centre authorised by the manufacturer and request original spare parts.
- 5) In no case whatsoever must you change the original settings of the machine without first having consulted the technical service centre authorised by the manufacturer;
- 6) Do not open the door too quickly while the machine is running.
- 7) Change the water in the wash tank even several times a day depending on the cycles carried out.

ADVICE TO ACHIEVE AN IDEAL WASHING RESULT

An unsatisfactory washing result can be seen when traces of filth remain on the dishes or objects; rings can be caused by insufficient rinsing.

In this case, check that the rinsing nozzles (18) are clean and that the water mains is pressurised;

If soiled, check that:

- The tank filter (15) is clean;
- the wash water temperature is approximately 55-60°C;
- the objects are positioned properly in the dish rack;
- the wash/rinse nozzles are clean (18);
- the spray arms (16) rotate freely.
- check the concentration of the detergent and rinse agent.

 IMPORTANT

Failure to comply with the above-mentioned recommendations could jeopardise the safety of the dishwasher.

2.2 CLEANING (Fig. 9)

2.2.a OVERVIEW

Strict observance of the maintenance rules in this section guarantees good preservation and satisfactory machine operation and greatly reduces the need for repairs.



ATTENTION

In case of irregularities or malfunctioning of any machine component, **FIRST OF ALL CHECK** that the instructions in the previous paragraphs have been followed.

Interventions must be carried out promptly at the onset of failures to prevent the problem from worsening and other parts being damaged.



ATTENTION

Daily operations to be carried out when the work is completed, with the machine **OFF**, the main switch disconnected, the water supply valve closed and the wash tank empty.

1. Clean the inside of the machine thoroughly.
2. Remove the overflow (14) **by turning it anti-clockwise** and lift it to perform cleaning.
3. Extract the tank filter (20) from the bottom of the machine and lift it to perform cleaning

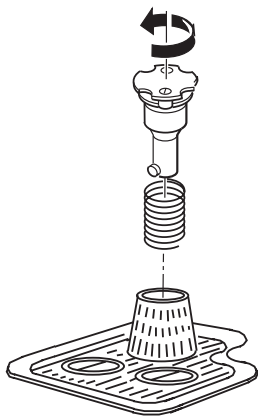

4. Wash the filters under running water and refit them correctly in their seats by following the inverse order.

2.3. MAINTENANCE (Fig. 9)

Before performing any maintenance, switch the machine off, disconnect the wall-mounted main switch, close the water supply valves and empty the tank.

2.3.a CHECKING and CLEANING THE SPRAY ARMS and NOZZLES (Fig. 9)

Periodically check that the upper and lower wash/rinse spray arm (16) rotates freely and that the relative nozzles (18) are not obstructed.

CLEANING THE LOWER/UPPER PB/PF45 UNIT:

1. Release the spray arm (16) by pressing the button in the middle (17) and lifting the spray arm (16).

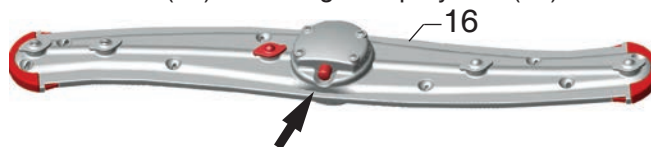

2. Disassemble the wash/rinse jets (18) and the side plugs (19) pressing them lightly. If the nozzles are obstructed, unscrew them to remove them. Clean the nozzles while paying attention not to deform their shape.
3. Refit the side plugs (19) and the nozzles (18) in the exact same position.

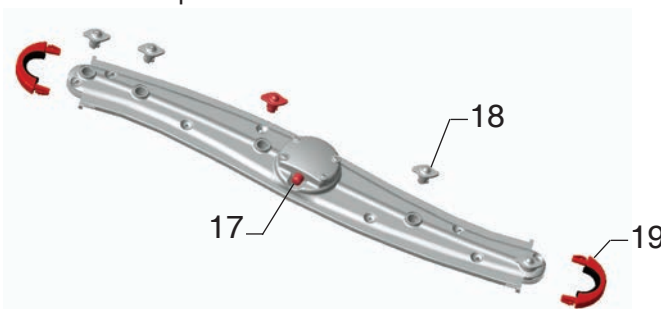

4. Reposition the wash/rinse spray arm.

CLEANING THE LOWER/UPPER PF46 UNIT:

1. Unscrew the ring nut (21/22) and lift the spray arms (23/24).
2. Wash the washing and rinsing spray arms. If there are clogged nozzles (20/25), clean them and then reassemble them exactly in their original position.
3. Reassemble everything in the inverse order.

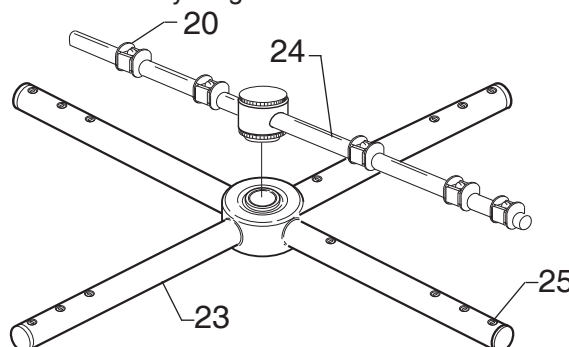

**ATTENTION**

Regularly check and clean the spray arms, removing them from the columns and removing any debris and deposits. The frequency of this operation depends on the amount of residue or on unsatisfactory washing results. To wash the outside of the machine, do not use corrosive products such as sodium hypochlorite (bleach) or hydrochloric acid (muriatic acid) with steel sponges or brushes.

2.4. DESCALING

In the presence of hard water, limestone deposits are formed inside the machine and on the dishes which, for hygienic and operational purposes, must be removed by descaling.

The operating procedures and their frequency are usually recommended by the supplier of the descaler who has appropriate products.

To avoid damaging the machine, do not exaggerate with the dosages, and strictly abide by the instructions of the descaler manufacturer. When the operations are completed, rinse with plenty of water.

2.5. PUTTING TEMPORARILY OUT OF SERVICE.

In case of a prolonged stop of a few weeks, before closing the machine, it is recommended to fill the tank with clean water and to perform a few empty cycles. Then drain the water so that bad smells are not produced and the pump does not remain dirty.

If necessary, repeat this operation several times until the water is clean after the empty wash cycle.

If the downtime is too long, it is recommended to oil the stainless steel surfaces with vaseline and to drain the water from the boiler and the electric pump.

2.6. DEMOLITION and WASTE DISPOSAL.

When you intend to scrap the machine, drain the water from the tank and the boiler, as indicated in the previous points, and disconnect the machine from the water and electric mains. Then dismantle the components following that prescribed in the relevant standards in force in compliance with the national and local ecological-environmental regulations, taking care to separate the parts as follows:

- metal parts: body, surfaces, panels, filters;
- electric parts: motors, contactors, microswitches, wires;
- plastic parts: fittings, dish racks;
- rubber parts: hoses, sleeves.

2.7 SCHEDULED and PREVENTIVE MAINTENANCE

It is recommended to service the machine according to the scheduled maintenance at least every 6 MONTHS, by contacting the authorised technical assistance service.

The manufacturer will not be held liable for any printing errors in this booklet.

The instructions, drawings, tables and all else contained in this booklet are of a confidential technical nature and therefore, the information cannot be reproduced, either in whole or in part, or disclosed to third parties without the written consent of the manufacturer who has exclusive ownership thereof and reserves the right to make any changes deemed appropriate without prior notice.

2.8. REGENERATION CYCLE (only for "A" models)

The regeneration phase of the resins **must start with the dishwasher ON, FULL TANK and DOOR CLOSED.**

2.8.a FILLING THE SALT TANK

First of all make sure that there is salt in the specific container; otherwise, proceed as follows:

1. Unscrew the cap from the tank and introduce **ONLY COARSE COOKING SALT.**
2. Fully screw the cap back on to make sure it is closed properly

2.8.b STARTING RESIN REGENERATION

Once the cycles set on the display are reached, **A9** appears on the display, which means **REGENERATION REQUIRED.**



Press the **SCROLL** key



Select the **C3** function from the display.



Press the **START** key.



The START key turns WHITE.



Open the DOOR.

Release the overflow by turning it anti-clockwise and close the DOOR again.

The **REGENERATION** phase begins.

When the cycle has begun, the display on the right will read **C3**. If the tank is not drained, the alarm **A10** will appear on the display at the end of the cycle.



ATTENTION

F1 appears if the door is opened during the regeneration



The regeneration cycle is interrupted and then resumes when the door is closed.

At the end of the cycle, the machine switches off automatically and the display reads **OFF**.



The machine is now ready for use.

ATTENTION

Pressing the **START** key for 5 sec. with the **REGENERATION** cycle in progress, the cycle is immediately interrupted, the dishwasher is switched off and **OFF** appears on the display.

If regeneration is interrupted it does not allow the indicated **REGENERATION REQUIRED** to be eliminated (alarm **A9** on the display), which will reappear upon the next switch-on.



IMPORTANT

Upon switch-on, after an interrupted regeneration, wait for the tank to be restored until the START key becomes **STEADY GREEN or **FLASHING GREEN**.**

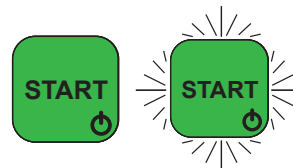

Run a complete **SELF-WASHING** cycle by performing the following steps:

Press the **SCROLL** key.



Select the **C1** function on the display.



To start the cycle, press the **START** key.



At the end of the **SELF-WASHING** cycle the dishwasher switches off and **OFF** will appear on the display.



The machine can be reused by re-inserting the overflow in its original position and switching the dishwasher on.

Due to the interrupted regeneration, alarm **A9** will remain on the display.

We recommend starting a regeneration cycle as soon as possible.







SUMMARISED TABLE OF DISPLAYED ALARMS

WARNING	ALARM DESCRIPTION
A1	CYCLE NOT COMPLETED
A2	BOILER OVERHEATING
A3	DISCONNECTED TEMPERATURE PROBE
A4	BOILER RCD and TANK FILL-UP TIMEOUT
A5	BOILER RCD HEATING TIMEOUT DURING THE INITIAL FILL-UP
A9	REGENERATION WARNING
A10	FULL TANK ALARM
H1	INSUFFICIENT RINSE WATER TEMPERATURE
H2	NO WATER (RCD)
H3	INSUFFICIENT WASH WATER TEMPERATURE

SUMMARISED TABLE OF DISPLAYED WARNINGS

WARNING	STATUS DESCRIPTION
F1	DOOR OPEN
F2	INITIAL TANK FILL-UP
C1	SELF-WASHING and DRAIN
C2	DRAIN
C3	REGENERATION

SUMMARISED TABLE OF START KEY WARNINGS

MACHINE STATUS	START KEY COLOUR
Machine OFF	none 
Machine in INITIAL FILL-UP phase	YELLOW (steady) 
FULL TANK (initial fill-up) TEMPERATURE NOT REACHED	GREEN (flashing) 
Machine READY FULL TANK TANK and BOILER WATER TEMPERATURE reached	GREEN (steady) 
CYCLE in PROGRESS	BLUE (steady) 
Machine in ALARM	RED (steady) 
Machine in REGENERATION	WHITE (steady) 

TROUBLESHOOTING

FAULT	CAUSE	SOLUTION
The machine does not switch on.	Main switch disconnected.	Enable switch.
Water does not fill	Water valve closed. Dirty fill-up solenoid valve filter. Rinse nozzles clogged. Overflow hose not inserted correctly ALARM A4: No water RCD pump not working (optional) WARNING F1: Door open	Open the valve. Clean the filter (4 Fig.6/7) Unscrew and wash the nozzles (18 Fig. 9) under running water Check that the overflow hose is inserted properly (14 Fig. 9). Check for mains water supply; Check the RCD pump operation Check that the door is closed perfectly and/or level/check levelling of the machine
Insufficient washing.	Wash nozzles clogged. Wash filter dirty. Blocked washing spray arm Detergent insufficient or missing. Insufficient wash conditions ALARM H3: Wash temperature insufficient ALARM A3: Probe disconnected or interrupted	Clean the nozzles of the washing spray arm (18 Fig. 9). Clean the filter (15 Fig. 9). Remove and clean the spray arm and support (16 Fig. 9) Restore the detergent in the tank and check its concentration. Check that the washing phase is carried out correctly. Wait for the tank to reach the adequate temperature and perform a new cycle. Contact the Assistance Service.
Insufficient rinsing.	Rinse nozzles clogged. Limestone obstruction in boiler. Poor water pressure (less than 2 bar - 200 Kpa). Insufficient temperature. Incorrect position of nozzles or nozzles damaged. ALARM H1: Rinse temperature insufficient ALARM H2: No RCD operation ALARM A3: Probe disconnected or interrupted ALARM A5: RCD boiler does not heat	Unscrew and wash the nozzles (18 Fig. 9) under running water Contact the Assistance Service. Wait for the pressure to be restored or purchase a new pressure pump. Contact the Assistance Service. Check that the nozzles are in the correct position and replace the damaged ones. Wait for the boiler to reach the adequate temperature. Contact the Assistance Service. Switch the machine off and on Contact the Assistance Service. Contact the Assistance Service. Contact the Assistance Service.

PART RESERVED
FOR THE
AUTHORISED
AND QUALIFIED
TECHNICIAN

 **IMPORTANT**

Any installation, electric or hydraulic connection, programming, maintenance operation, etc. must be carried out by **QUALIFIED** personnel **AUTHORISED** by the manufacturer; operations carried out by **UNQUALIFIED** personnel can jeopardise the safety of the operator as well as other personnel (user, etc.) or the system connected to the dishwasher. The manufacturer will not be held liable for accidents to persons or objects resulting from failure to comply with the above rules.

3.1 INSTALLATION (Fig. 6)

- After having removed the packaging, make sure that the machine is intact and that all the supplied parts are present.
- Position the machine in its final installation site and level it by actuating the adjusting feet (20).

3.1.a DRAIN HOSE CONNECTION (Fig. 6)

- Connect the drain hose (5) to a preset drain well.

 **IMPORTANT**

Make sure that the drain hose runs flush along the floor and has no bottlenecks.

3.1.b WATER CONNECTION (Fig. 6)

- Connect the supplied filler hose (4) to the solenoid valve and the other end of the filler hose (4) to a 3/4" G threaded valve and apply the filter (8).

 **ATTENTION**

It is mandatory to connect the water supply hose to a shut-off valve in order to separate the supply system from the machine itself and to check that there are no bottlenecks.

Wherever sand is found in the water supply circuit, a filter must be applied between the water circuit and the machine. If it has none, it is recommended to install a descaler upstream of the machine with calibration set to min 4 max 8 French degrees.

The manufacturer will not be held liable for damage to the machines resulting from failure to comply with the above rules.

3.1.c ELECTRIC CONNECTION (Fig. 5)

 **DANGER**

- Before performing the electrical connection, make sure that the data on the power line correspond to those indicated on the rating plate (pos. 3 Fig. 5) and that the main electric power switch upstream of the machine is disconnected (position O/OFF).
- An omnipolar power switch, appropriately sized with a minimum contact opening of 3 mm must be installed between the power line and the machine.
- Connect the power cable (9) to the main switch upstream of the machine.
- Connect the equipotential earth electrode to the terminal (7).
- The power cable **CANNOT** be replaced by the user but **ONLY** by technical assistance.
- There must be an efficient earthing system, compliant with prevention standards in force, for the safety of the operator and the equipment.
- The power cable must not be pulled or crushed during normal operation or routine maintenance.
- The equipotential terminal fixed to the body must be connected to an equipotential cable with a suitable cross-section for the application.



- Respect the polarities of the wiring diagram.
- For further information, see the attached wiring diagram.

The manufacturer will not be held liable for accidents to persons or objects resulting from failure to comply with the above rules.

DISPLAYED ALARMS and WARNINGS: SELF-DIAGNOSTICS

If an ALARM or WARNING condition occurs, the relative code will be displayed.

The START key turns RED until normal conditions are restored.



The alarm and warning codes of the active functions displayed during machine operation are:

A1 CYCLE NOT COMPLETED

This alarm is displayed when the wash cycle was interrupted by switching the machine off with the START key.
The alarm is reset when the next wash cycle starts.



A 5 RCD BOILER HEATING TIMEOUT DURING THE INITIAL FILL-UP

This alarm is displayed when the boiler is not heated **within 30 minutes**.
The alarm can be reset by turning the machine off and on by pressing the START key.



A2 ANOMALOUS OVERHEATING (BOILER)

This alarm is displayed when the temperature in the boiler **exceeds 105 °C** or when at least one of the temperature probes (tank/boiler) is short-circuited.
The alarm is reset when the temperature **drops below 102 °C** or when the probe is replaced.



A9 REGENERATION WARNING

This alarm is displayed when the set cycles are reached. The alarm is reset after the resin regeneration cycle is completed.



A 3 TEMPERATURE PROBE DISCONNECTED

This alarm is displayed when one of the temperature probes (boiler and/or tank) is disconnected or interrupted.
The alarm is reset when the probe is reconnected properly.



A10 FULL TANK WARNING

This alarm is displayed if the tank is not empty once the drain, self-washing or regeneration phases have been started.
The alarm can be reset by turning the machine off and on by pressing the START key



A 4 FILL-UP TIMEOUT

This alarm is displayed when the tank does not fill **within 30 minutes** or the RCD boiler does not fill **within 8 minutes**.

The alarm can be reset by turning the machine off and on by pressing the START key.



H 1 INSUFFICIENT RINSE WATER TEMPERATURE

This alarm is displayed if, during the wash cycle, the rinse phase is carried out with the boiler **at least 15 °C** lower than the set temperature.
The washing cycle is prolonged until the minimum rinsing temperature is reached (**max 8 minutes**).



H2 NO WATER (RCD)

This alarm is displayed when the rinse phase is not carried out correctly.
Reset the alarm by turning the machine off and on from the START key.

