

Vector™ Multi-Cook Oven

Simple Control

VMC-H2

VMC-H2H

VMC-H3

VMC-H3H

VMC-H4

VMC-H4H



Structured Air Technology™

MN-46548-EN

REV.01
11/19

EN



Manufacturer's Information

Copyright

© Copyright 11/19 by Alto-Shaam, Inc.

All rights reserved.

This manual or any portion thereof may not be reproduced or used in any manner whatsoever without the express written permission of Alto-Shaam, Inc.

Trademarks

All trademarks referenced in this documentation are the property of their respective owners.

Manufacturer

Alto-Shaam, Inc.

P.O. Box 450

W164 N9221 Water Street

Menomonee Falls, WI 53052

Original instructions

The content in this manual is written in American English.

Enjoy your Alto-Shaam Vector Oven!

Structured Air Technology™

The Alto-Shaam Vector Oven features Structured Air Technology, giving you two, three or four ovens in one. It gives you the flexibility to simultaneously cook a variety of menu items with no flavor transfer. It provides the ability to control temperature, fan speed, and time in each individual oven chamber.

Cook up to twice the food than a traditional convection oven, with no microwaves, and no water.

Extend Your Manufacturer's Warranty

Register

Register your Alto-Shaam appliance online. Registering your appliance ensures prompt service in the event of a warranty claim. You will also receive direct notifications of software updates and additional product information.

Your personal information will not be shared with any other company.

www.alto-shaam.com/warranty

Alto-Shaam 24/7 Emergency Repair Service

Call

Call 800-558-8744 to reach our 24-hour emergency service call center for immediate access to local authorized service agencies outside standard business hours. The emergency service access is provided exclusively for Alto-Shaam equipment and is available throughout the United States through Alto-Shaam's toll free number.

Availability

Emergency service access is available seven days a week, including holidays.

This page intentionally left blank.

Manufacturer’s Information 2

Foreword 3

 Enjoy your Alto-Shaam Vector Oven! 3

 Extend Your Manufacturer’s Warranty 3

 Alto-Shaam 24/7 Emergency Repair Service 3

Table of Contents 5

Safety 7

 The Meaning of Signal Words 7

 Appliance Description and Intended Use. 8

 Safety Precautions. 9

Labels 13

 Label Locations 13

Installation 17

 Dimension Drawings 17

 How to Receive the Appliance 18

 How to Unpack the Oven 19

 Vector Pre-Installation Checklist. 20

 Installation Checklist 24

 How to Install the Oven (60 Hz Cord and Plug Models). 26

 How to Install the Oven (60 Hz Models Without Cords or Plugs) . . . 29

 How to Install the Oven (50 Hz Models Without Cords or Plugs) . . . 34

 How to Install the Oven on a Stand 40

Operation 43

 How to Turn On and Turn Off the Oven 43

 How to Set Preheat Temperatures 44

 How to Preheat the Oven. 47

 How to Cook in Manual Mode 49

 How to Use the Dual Timers 51

 How to Cook with Programmed Recipes 54

 How to Cook with Linked Chambers 56

 How to Create and Edit Recipes 58

 How to Create and Edit Recipe Folders 60

 How to Load Recipes from a USB Drive. 62

 How to Save Recipes to a USB Drive 64

 How to Turn On and Turn Off the Chambers 66

 How to Enable Auto Cool 67

 How to Enable Manual Mode, Linking, and Set Temp Function 69

 How to Enable Auto Preheat. 71

 How to Change the Time and Date Settings 73

TABLE OF CONTENTS

How to Change the Sound Settings.	74
How to Change the Temperature Scale	75
How to Set the Cleaning Timer	76
How to View the Oven Logs	78
How to Adjust the Oven Light Duration	80
Maintenance	81
Maintenance Schedule	81
How to Clean the Oven.	82
Troubleshooting	87
What to do if the Fan Indicator Light Illuminates	87
What to do if the High Limit Screen Displays	88
Warranty	89
Warranty.	89

The Meaning of Signal Words

This manual contains signal words where needed. These signal words must be obeyed to reduce the risk of death, personal injury, or equipment damage. The meaning of these signal words is explained below.

**DANGER**

Danger indicates a hazardous situation which, if not avoided, will result in serious injury or death.

**WARNING**

Warning indicates a hazardous situation which, if not avoided, could result in serious injury or death.

**CAUTION**

Caution indicates a hazardous situation which, if not avoided, could result in minor or moderate injury.

NOTICE

Notice indicates a situation which, if not avoided, could result in property damage.



NOTE: Note indicates additional information that is important to a concept or procedure.

Appliance Description and Intended Use

Structured Air Technology™

Alto-Shaam Vector's Structured Air Technology system allows for multiple, unique cooking chambers within the same oven. Air is delivered by a blower located in the rear of each cooking chamber. Air travels vertically through the jet plates into each chamber. The food product is blown with hot air from above and below. Structured Air plates at the top and bottom of the oven complete the upper and lower cooking chambers. Each cooking chamber is independent from the other and includes its own blower and heat source. The operator can select the optimal cooking temperature, air velocity, and cook time for each chamber either manually or through programmed recipes.

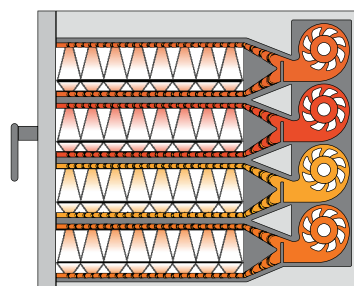

5:30



60%



400°

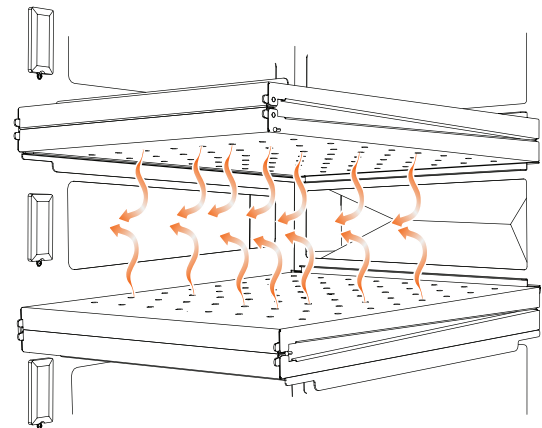

VMC-TS-000271

Configurations

The Vector H Series is available in three configurations: two-, three-, and four-chamber.

Intended use

The Vector series ovens are intended to cook and warm food only. Any other use is prohibited.

Residual risks

This oven is manufactured using ISO-certified processes. The oven is designed with maximum safety in mind; however, there are residual risks to operators of this oven. Residual risks include exposure to heat and exposure to hot food products.

Possible misuse

Misuse of this oven includes loading the oven with anything other than a food product. Misuse also includes heating or cooking any food product that contains alcohol or other flammable substance.

Safety Precautions

Before you begin

Read and understand all instructions in this manual.

Electrical precautions

Obey these electrical precautions when using the appliance:

- Connect the appliance to a properly grounded outlet. Do not use the appliance if it is not properly grounded. Consult an electrician if there is any doubt that the outlet used is properly grounded.
 - Keep the cord away from hot surfaces.
 - Do not attempt to service the appliance or its cord and plug.
 - Do not operate the appliance if it has a damaged cord or plug.
 - Do not immerse the cord or plug in water.
 - Do not let the cord hang over the edge of a table or counter.
 - Do not use an extension cord.
-

Usage precautions

Obey these usage precautions when using the appliance:

- Only use this appliance for its intended use of heating or cooking.
 - Always keep liquids, or foods that can become liquid when heated, level and at or below eye level where they can be seen.
 - Use utensils and protective clothing such as dry oven mitts when loading and unloading the appliance.
 - Use caution when using the appliance. Floors adjacent to the appliance may become slippery.
 - Do not cover or block any of the openings of this appliance.
 - Do not cover racks or any other part of this appliance with metal foil.
 - Do not use this appliance near water such as a sink, in a wet location, near a swimming pool, or similar locations.
 - Do not unplug or disconnect the appliance immediately after cooking. The cooling fans must stay on to protect electrical components.
-

Maintenance precautions

Obey these maintenance precautions when maintaining the appliance:

- Obey precautions in the manual, on tags, and on labels attached to or shipped with the appliance.
- Only clean the appliance when the main disconnect switch is in the OFF position.
- Do not store the appliance outdoors.
- Do not clean the appliance with metal scouring pads.
- Do not use corrosive chemicals when cleaning the appliance.
- Do not use a hose or water jet to clean the appliance.
- Do not use the appliance cavity for storage.
- Do not leave flammable materials, cooking utensils, or food inside the appliance when it is not in use.
- Do not remove the top cover or side panels. There are no user-serviceable components inside.

Operator training

All personnel using the appliance must have proper operator training. Before using the appliance:

- Read and understand the operating instructions contained in all the documentation delivered with the appliance.
 - Know the location and proper use of all controls.
 - Keep this manual and all supplied instructions, diagrams, schematics, parts lists, notices, and labels with the appliance if the appliance is sold or moved to another location.
 - Contact Alto-Shaam for additional training if needed.
-

Operator qualifications

Only trained personnel with the following operator qualifications are permitted to use the appliance:

- Have received proper instruction on how to use the appliance.
- Have demonstrated their ability with commercial kitchens and commercial appliances.

The appliance must not be used by:

- Persons (including children) with reduced physical, sensory or mental capabilities, or lack of experience and knowledge, unless they have been given supervision concerning use of the appliance by person responsible for their safety.
 - People impaired by drugs or alcohol.
-

- Children should be supervised to ensure that they do not play with the appliance.
 - Children shall neither clean nor maintain the appliance.
-

Condition of appliance

Only use the appliance when:

- All controls operate correctly.
 - The appliance is installed correctly.
 - The appliance is clean.
 - The appliance labels are legible.
-

Servicing the appliance

- Only trained personnel are permitted to service or repair the appliance. Repairs that are not performed by an authorized service partner or trained technician, or the use of non-factory parts, will void the warranty and relieve Alto-Shaam of all liability.
 - To prevent serious injury, death or property damage, have the appliance inspected and serviced at least every twelve (12) months by an authorized service partner or trained technician.
 - Contact Alto-Shaam for the authorized service partner in your area.
-

Sound power

The A-weighted sound pressure level is below 70 dB(A).

Personal Protective Equipment (PPE)

Wear the following Personal Protective Equipment (PPE) while cleaning the appliance:

- Protective gloves
- Protective clothing
- Eye protection
- Face protection



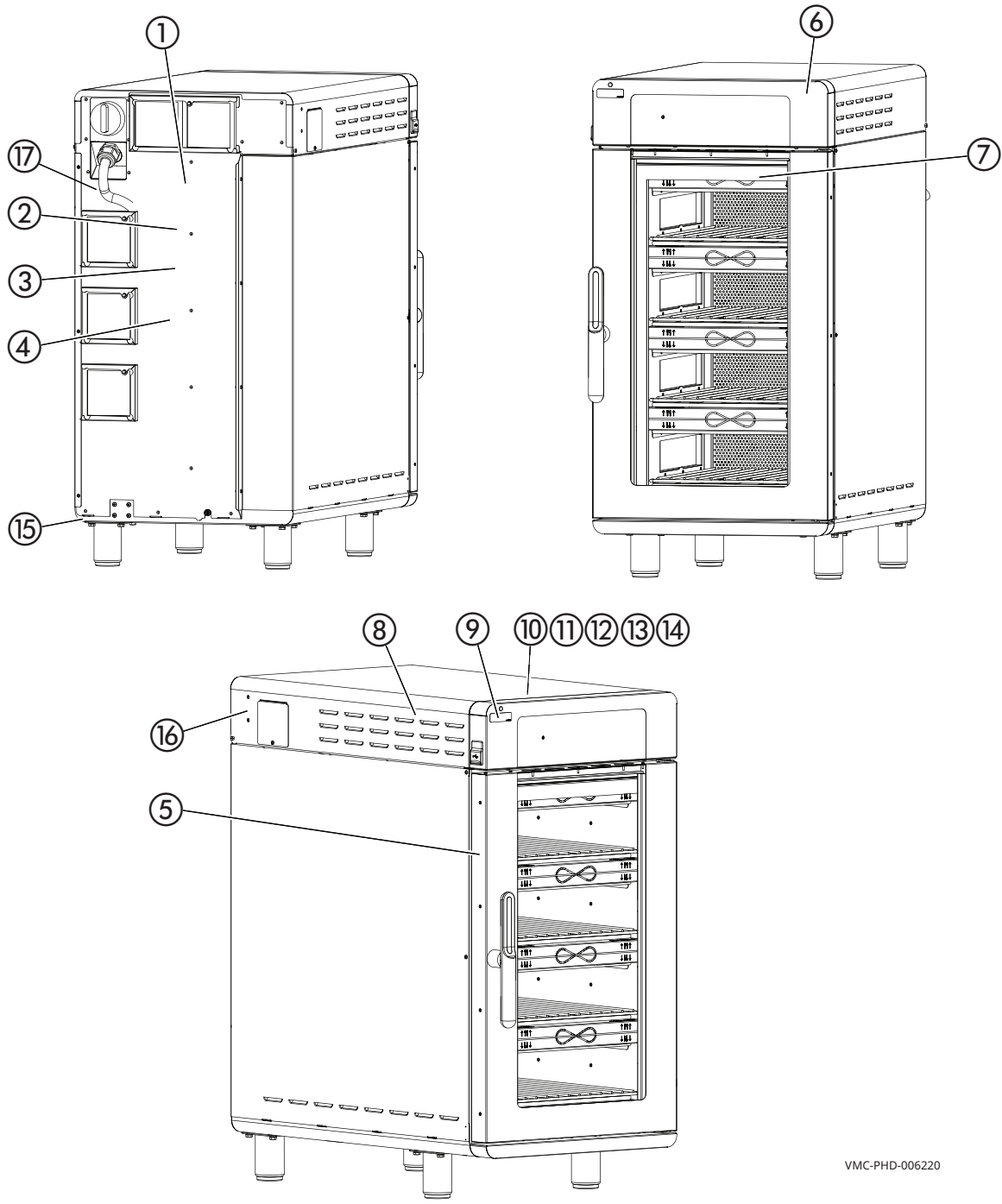

This page intentionally left blank.





Label Locations

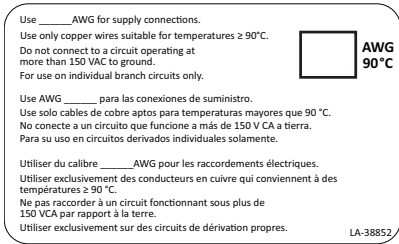
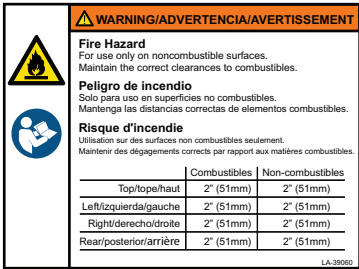
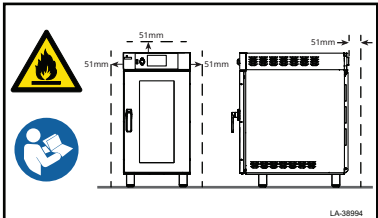



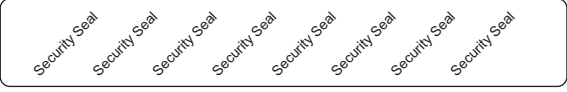
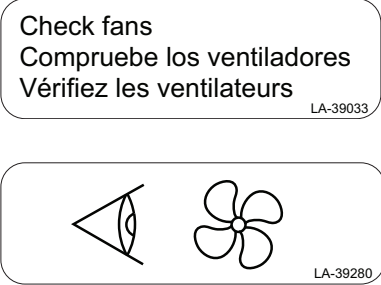

VMC-PHD-006220

LABELS

<p>1</p>	 <p>WARNING/ADVERTENCIA/AVERTISSEMENT</p> <p>Electric Shock Hazard To reduce the risk of electric shock, do not remove or open cover. No user-serviceable parts inside. Refer servicing to qualified personnel. Qualified personnel: Disconnect power before servicing.</p> <p>Peligro de descarga eléctrica Para reducir el riesgo de descarga eléctrica, no retire ni abra la cubierta. No hay piezas en el interior a la que se les pueda realizar mantenimiento. Derive el mantenimiento a personal calificado. Personal calificado: Desconecte la energía antes de realizar mantenimiento.</p> <p>Danger de décharge électrique Pour réduire le risque de décharge électrique, ne par ouvrir ni retirer le capot. Ne confiez pas de pièces réparables par l'utilisateur. Confier les réparations à du personnel qualifié. Personnel qualifié : Sectionnez l'alimentation avant toute intervention.</p> <p>LA-38950</p> 	<p>WARNING</p> <p>Electric shock hazard</p> <p>To reduce the risk of electric shock, do not remove or open the cover. No user-serviceable parts inside. Refer servicing to qualified personnel. Qualified personnel: Disconnect power before servicing.</p>															
<p>2</p>	 <p>Use ____ AWG for supply connections. Use only copper wires suitable for temperatures $\geq 90^{\circ}\text{C}$. Do not connect to a circuit operating at more than 150 VAC to ground. For use on individual branch circuits only.</p> <p>Use AWG ____ para las conexiones de suministro. Use solo cables de cobre aptos para temperaturas mayores que 90°C. No conecte a un circuito que funcione a más de 150 V CA a tierra. Para su uso en circuitos derivados individuales solamente.</p> <p>Utiliser du calibre ____ AWG pour les raccordements électriques. Utiliser exclusivement des conducteurs en cuivre qui conviennent à des températures $\geq 90^{\circ}\text{C}$. Ne pas raccorder à un circuit fonctionnant sous plus de 150 VCA par rapport à la terre. Utiliser exclusivement sur des circuits de dérivation propres.</p> <p>AWG 90°C</p> <p>LA-38852</p>	<p>Note: This label is only used on UL-certified appliances that have 120V to ground wiring.</p> <p>Use ____ AWG for supply connections.</p> <p>Use only copper wires suitable for temperature less than or equal to 90°C.</p> <p>Do not connect to a circuit operating at more than 150 VAC to ground.</p> <p>For use on individual branch circuits only.</p>															
<p>3</p>	 <p>WARNING/ADVERTENCIA/AVERTISSEMENT</p> <p>Fire Hazard For use only on noncombustible surfaces. Maintain the correct clearances to combustibles.</p> <p>Peligro de incendio Solo para uso en superficies no combustibles. Mantenga las distancias correctas de elementos combustibles.</p> <p>Risque d'incendie Utilisation sur des surfaces non combustibles seulement. Maintenir des dégagements corrects par rapport aux matières combustibles.</p> <table border="1"> <thead> <tr> <th></th> <th>Combustibles</th> <th>Non-combustibles</th> </tr> </thead> <tbody> <tr> <td>Top/above/haut</td> <td>2" (51mm)</td> <td>2" (51mm)</td> </tr> <tr> <td>Left/leftierda/gauche</td> <td>2" (51mm)</td> <td>2" (51mm)</td> </tr> <tr> <td>Right/derecho/droite</td> <td>2" (51mm)</td> <td>2" (51mm)</td> </tr> <tr> <td>Rear/posterior/arrière</td> <td>2" (51mm)</td> <td>2" (51mm)</td> </tr> </tbody> </table> <p>LA-38900</p>  <p>LA-38994</p>		Combustibles	Non-combustibles	Top/above/haut	2" (51mm)	2" (51mm)	Left/leftierda/gauche	2" (51mm)	2" (51mm)	Right/derecho/droite	2" (51mm)	2" (51mm)	Rear/posterior/arrière	2" (51mm)	2" (51mm)	<p>WARNING</p> <p>Fire hazard</p> <p>For use only on noncombustible surfaces. Maintain the correct clearances to combustibles.</p>
	Combustibles	Non-combustibles															
Top/above/haut	2" (51mm)	2" (51mm)															
Left/leftierda/gauche	2" (51mm)	2" (51mm)															
Right/derecho/droite	2" (51mm)	2" (51mm)															
Rear/posterior/arrière	2" (51mm)	2" (51mm)															
<p>4</p>	 <p>ALTO-SHAAM.</p> <p>Every Alto-Shaam product is precision calibrated prior to release from the factory to ensure accurate temperature control.</p> <p>CALIBRATION TECHNICIAN _____</p> <p>LA-26378</p>	<p>Every Alto-Shaam product is precision calibrated prior to release from the factory to ensure accurate temperature control.</p>															

5		<p>WARNING Hot surface</p>
6		<p>Made in U.S.A.</p>
7		<p>WARNING Burn hazard Always load liquids, or foods that can become liquid when heated, at an eye level where they can be seen.</p>
8		<p>Security seal</p>
9		<p>Check fans</p>
10		<p>Line 1 supply terminal</p>
11		<p>Line 2 supply terminal</p>

LABELS

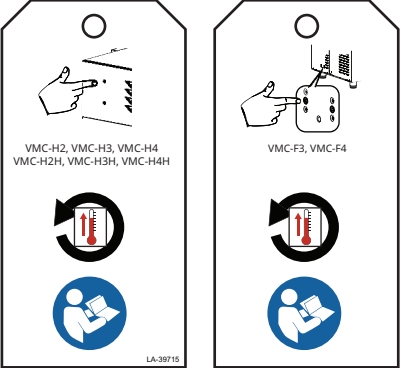
12		Line 3 supply terminal
13		Neutral
14		Ground terminal
15		Equipotential terminal
16		Press and release the high limit temperature reset button(s).

Dimension Drawings

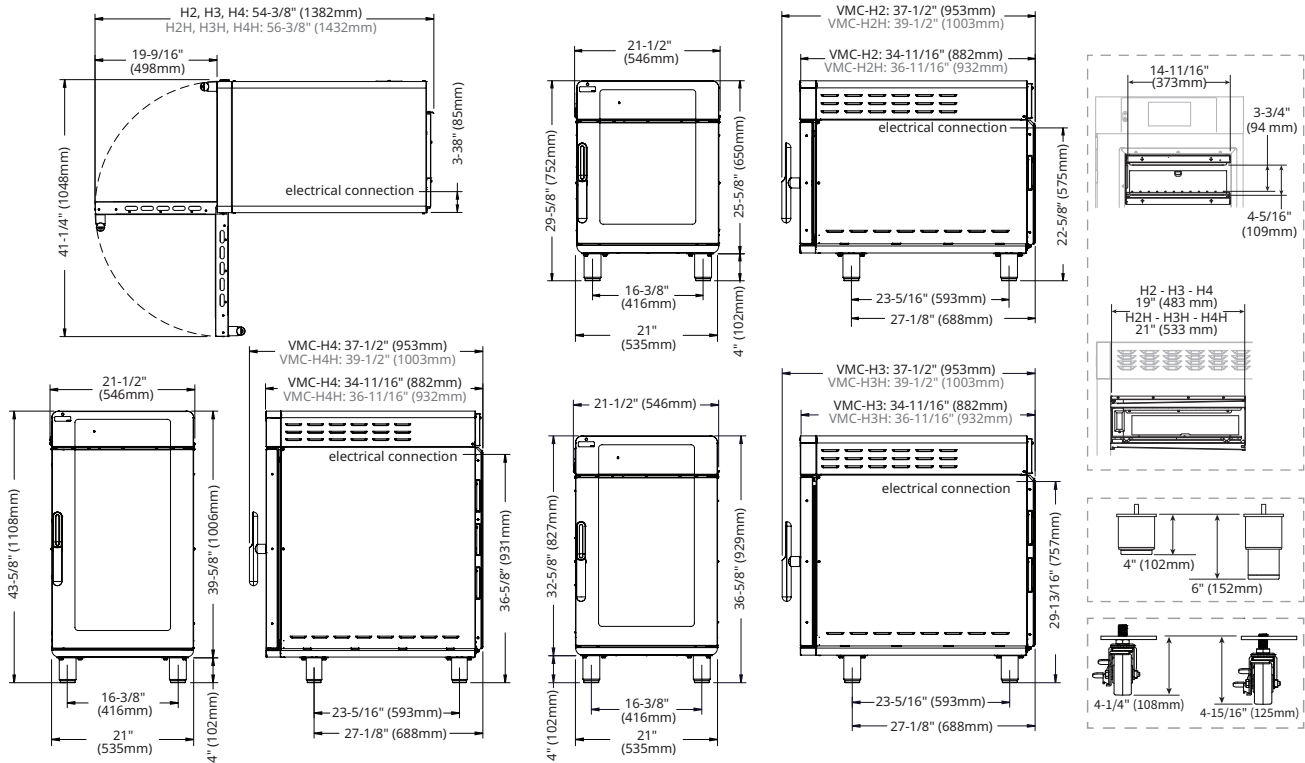

INSTALLATION

How to Receive the Appliance

Responsible parties

When an Alto-Shaam preferred carrier is used, shipping damage is a matter between Alto-Shaam and the carrier. In such cases, contact Alto-Shaam customer service.

When an Alto-Shaam non-preferred carrier is used, shipping damage is a matter between the carrier and the consignee. In such cases, the carrier is assumed to be responsible for the safe delivery of the merchandise, unless negligence can be established on part of the shipper.

Receive the appliance

When receiving the appliance, do the following.

Step	Action
1.	Inspect the equipment while it is still in the truck or immediately after it is moved to the receiving area. Do not wait until after the equipment is moved to a storage area.
2.	Inspect and count all merchandise received. Do not sign a delivery receipt or a freight bill until you have done so.
3.	Note all damage to packaging and to the equipment on the carrier's receipt.
4.	Request the driver sign the delivery receipt. If the driver refuses to sign, make a note of this refusal on the delivery receipt.
5.	Write the following on the delivery receipt if the driver refuses to allow an inspection: Driver refuses to allow inspection of containers for visible damage.
6.	Contact the carrier immediately upon finding damage, and request an inspection. Follow the carrier's policies and procedures.

Alto-Shaam policy

It is the policy of Alto-Shaam to assist customers in collecting claims that have been properly filed and actively pursued. Alto-Shaam cannot, however, file damage claims, assume the responsibilities for damage claims, or accept deductions in payment for damage claims.

How to Unpack the Oven

Before you begin

Make sure you have:

- An appropriate lifting device and enough personnel to safely move and position the weight of the oven.
 - VMC-H2/H2H: 213 lb (97 kg)
 - VMC-H3/H3H: 278 lb (126 kg)
 - VMC-H4/H4H: 348 lb (158 kg)
- Cutting tools to remove the packaging.

Unpack the oven

To unpack the oven, do the following.

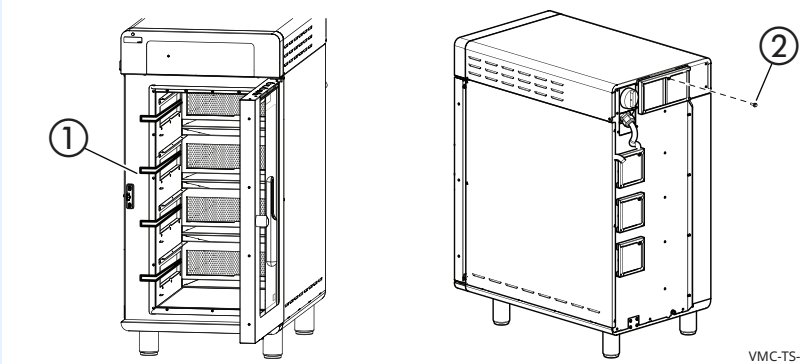
Step	Action
1.	Remove the box. Save all packing materials for inspection by the carrier. <div style="border: 1px solid black; padding: 5px; margin-top: 10px;"> <p>NOTE: Examine the appliance for damage. If the appliance has been damaged, do not use the appliance until it has been inspected by an authorized service provider. Contact your carrier or Alto-Shaam customer service.</p> </div>
2.	Remove the shrink wrap.
3.	Cut the restraining straps.
4.	Remove the tape ① that holds the filters (if equipped). Remove the screws ② that holds the filters (if equipped).
 <p style="text-align: right; font-size: small;">VMC-TS-007663</p>	
5.	Remove the foam from each chamber.
6.	Remove the oven from the pallet.

Result

The oven is now unpacked.

Vector Pre-Installation Checklist

Installation of the oven is to be completed only by an authorized Alto-Shaam service partner.

Place this form with the oven's records.



WARNING: Electric shock and arc flash hazard.
Use caution when measuring line voltage and line current.
Wear Personal Protective Equipment (PPE).

Location Information

Installation date:	Start up date:
Location name:	Location address:
Contact name:	
Contact phone number:	Number of ovens to be installed:
Contact email:	Oven model number(s):
IT Administrator name: (if applicable)	Oven serial number(s):
Phone number:	Oven rated voltage:

Pre-Installation Company Information

Company name:	Mailing address:
Technician name:	
Technician phone number:	Technician email:
Date of Site Survey:	

Clearance	Record	Pass	Fail
Measure door/entry way clearance (smallest dimension)			
Measure path clearance (smallest dimension)			
Elevator opening, if applicable (smallest dimension)			
Elevator interior dimensions, if applicable (HXWXD)			
Oven Clearance Right side:			
Rear:			
Left side:			
Top:			
Based on the oven's designated spot in the kitchen, is the oven accessible for service?	Yes / No		
If NO, comment on the issue:			
Other comments:			

Continued on next page

Continued from previous page

Electrical

Alto-Shaam oven ratings	Breaker:	Voltage:	Phase:	
The following fields must be completed by the service technician on site.				
What is the measured voltage at the site?	L1-N:	L2-N:	L3-N:	L1-L2:
	L2-3:	L1-L3:	Pass	Fail
What is the on-site breaker size supplying power to the oven(s)?	Size:		Pass	Fail
Is there a disconnect or junction box within 3' (914mm) of where the oven(s) will be installed?	Pass	Fail		
Comments:				

Gas-F Series only

What is the gas type for the oven(s) to be installed?	Natural	Propane		
What is the gas type confirmed at installation site?	Natural	Propane	Pass	Fail
Is there a minimum of one 3/4" gas supply line within 3' (914mm) of where the oven(s) will be installed?	Pass	Fail		
On the gas line, is there a 3/4" NPT pipe connection with a shut-off valve within 3' (914mm) of where the oven(s) will be installed?	Pass	Fail		
Comments:				

Wifi equipped ovens

Is the Wifi system that be used secure, Wifi Protected Access 2 (WPA2)? The Wifi system to be used cannot be Point of Sales Wifi.	Yes	No
Have you been provided the Service Set Identifier (SSID) for the system to be used?	Yes	No
Have you been provided the pass phrase for the Wifi system to be used?	Yes	No
At the final location that the oven will be installed, can you connect to the Wifi system with your phone?	Yes	No
At the final location that the oven will be installed, can you connect to Alto-Shaam.com with your phone using the Wifi system?	Yes	No
Is site action required?	Yes	No
Action required:		

Continued on next page

Continued from previous page

Other site information

Is there a proper ventilation hood installed above where the oven(s) will be installed? (If required)	Pass	Fail
Does the designated location for the oven have a level surface, i.e., no more than 1.5" (38mm) change in elevation from its highest to lowest surface point?	Pass	Fail
Is the site 100% ready for oven(s) installation?	Pass	Fail
Is site action required?	Pass	Fail

Action required:

Continued on next page

Continued from previous page

Please provide a copy of this document to an on-site manager.

Service company name:

Service company number:

Model of oven(s) to be installed:

The site is ready for installation of the oven(s); planned install location passes inspection. Once the oven(s) arrive at the site (or the delivery date is certain), please contact the service company listed above to schedule the installation.

The site is NOT ready for installation of the oven(s); planned install location needs the following changes made before installation can proceed:

On-site manager should make the necessary contacts to move forward with these changes as soon as possible. If there are any questions, please contact Alto-Shaam Technical Service Department at 800-558-8744 ext. 6702.
Or, review documentation regarding the equipment www.alto-shaam.com/en/resource-library.

Once the necessary site changes have been made and the oven(s) have arrived (or the delivery date is certain), please contact the service company listed above to schedule the installation.

Technician name and signature:

On-site manager name and signature:

Installation Checklist

Installation of the oven is to be completed only by an authorized Alto-Shaam service partner.

Place this form with the oven's records.



WARNING: Electric shock and arc flash hazard.
Use caution when measuring line voltage and line current.
Wear Personal Protective Equipment (PPE).

Installation date:	Start up date:
Location name:	Location address:
Contact name:	
Contact phone number:	Oven model number:
Contact email:	Oven serial number:
IT Administrator name: (if applicable)	Oven rated voltage:
Phone number:	

Oven physical condition	Damaged		Record any damage with details before or after uncrating, location of damage, etc. Take pictures.
	Yes	No	
Front of oven			
Left side			
Back of oven			
Right side			
Top and bottom/legs			

Oven visual inspection (outside)	Yes	No
Is all packing material removed from the outside of the oven?		
Is all packing material removed from the inside of the oven?		
Are all of the cooling fan filters installed correctly?		
Are all of the internal grease filters installed correctly? (H Series models only)		
Are all of the jet plates in place and installed correctly?		

Oven visual inspection (internal)	Loose/Damaged	
	Yes	No
Check all electrical connections at each terminal block.		
Check all circuit board connections.		
Check all components for loose connections and hardware.		
Check the overall system for any damage from shipping or installation.		

Continued on next page

Continued from previous page

Electrical:	Record		
Measure the voltage at the wall outlet.	L1 to L2:	L1 to L3:	L2 to L3:
Measure the voltage at the oven's main disconnect switch.	L1 to L2:	L1 to L3:	L2 to L3:
Measure the voltage at the oven's main terminal block.	L1 to L2:	L1 to L3:	L2 to L3:
Measure the AC voltage to the 12 VDC power supply.			
Measure the DC output from the power supply.			

Turn the oven on. Press and release the high limit temperature reset buttons. Start the preheat cycle for all of the oven chambers.

Terminals A1 to A2	Record	F Models	Record
SSR 1 DC voltage		SSR 5 DC voltage	
SSR 2 DC voltage		SSR 6 DC voltage	
SSR 3 DC voltage		SSR 7 DC voltage	
SSR 4 DC voltage		SSR 8 DC voltage	

Heating elements:	Left side	Right side	
	Record	F Models	Record
Amperage for chamber 1		Amperage for chamber 1	
Amperage for chamber 2		Amperage for chamber 2	
Amperage for chamber 3		Amperage for chamber 3	
Amperage for chamber 4		Amperage for chamber 4	

Wifi equipped ovens:

Navigate to the settings screen, touch the network icon.



On the Your network status screen:	Wireless	Ethernet
What is the connection type?		
What color is the network icon? 	Red Yellow	Green
What is the Internet status?		
What is the Cloud status?		
What is the SSID?		
What is the IP Address?		

How to Install the Oven (60 Hz Cord and Plug Models)

Before you begin

Make sure you have:

- An appropriate lifting device, and enough personnel, to safely move and position the weight of the oven.
 - VMC-H2/H2H: 213 lb (97 kg)
 - VMC-H3/H3H: 278 lb (126 kg)
 - VMC-H4/H4H: 348 lb (158 kg)

Requirements

- The oven must be installed on a level surface.
- The oven must not be installed in any area where it may be affected by steam, grease, dripping water, high temperature, or any other severely adverse conditions.
- The oven is not intended for built-in installation.

Voltages

	V	Ph	Hz	A	Breaker*	kW	Plug Configuration**
VMC-H2/ VMC-H2H	208	1	60	25	30	5.2	NEMA 6-30P
	240	1	60	28	30	6.7	NEMA 6-30P
VMC-H3/ VMC-H3H	208	1	60	38	50	7.9	NEMA 6-50P
	240	1	60	43	50	10.3	NEMA 6-50P
	208	3	60	22	30	7.9	NEMA 15-30P/L15-30P
	240	3	60	25	30	10.3	NEMA 15-30P/L15-30P
VMC-H4/ VMC-H4H	208	3	60	33	40	10.6	NEMA 15-50P
	240	3	60	38	40	13.9	NEMA 15-50P

*Electrical connections must meet all applicable federal, state, and local codes.

**No cord, no plug in Canada.

Continued on next page

Continued from previous page

Position the oven

To position the oven, do the following.

Step	Action
1.	<p>Make sure that:</p> <ul style="list-style-type: none"> The location where the oven is being installed is rated to support the weight of the oven; The oven is within five feet (1.5m) of the appropriate electrical outlet; You follow the oven clearance guidelines.
	
2.	<p>Move the oven to the installation location and onto the final resting surface.</p>

1. **Make sure** that:

- The location where the oven is being installed is rated to support the weight of the oven;
- The oven is within five feet (1.5m) of the appropriate electrical outlet;
- You follow the oven clearance guidelines.

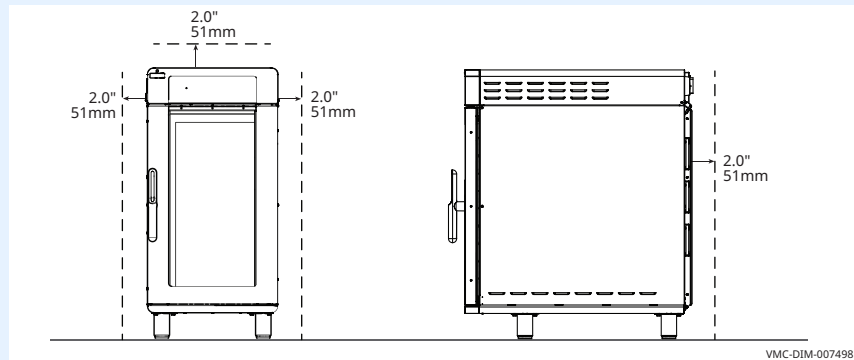

VMC-DIM-007498

2. **Move** the oven to the installation location and onto the final resting surface.

The oven is now correctly positioned.

Level the oven

To level the oven, do the following.

3. **Check** the level of the oven using a spirit (bubble) level. Check front to back and side to side.

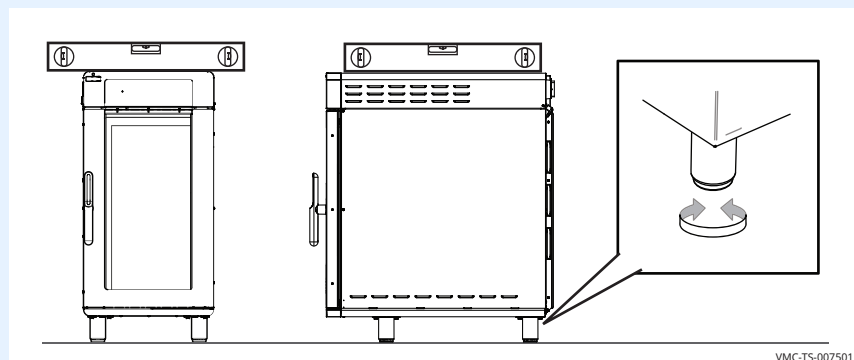

VMC-TS-007501

Adjust the legs, if necessary, to achieve levelness.

The oven is now correctly positioned.

Continued on next page

Continued from previous page

Connect power

To connect electric power to the oven, do the following.

4. **Set** the main disconnect switch ① to the OFF position.

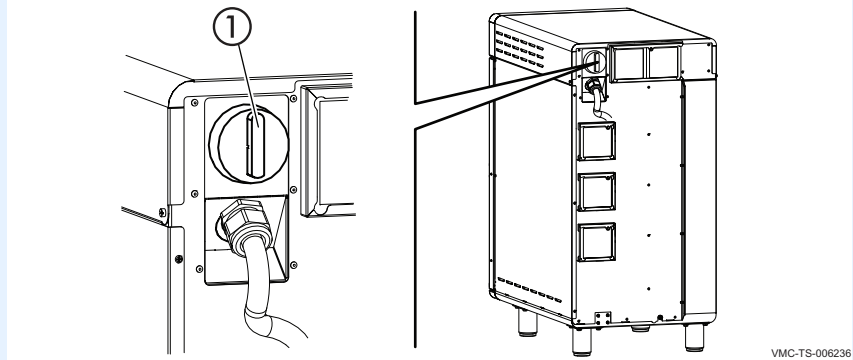

5. **Connect** the plug to the electrical outlet.

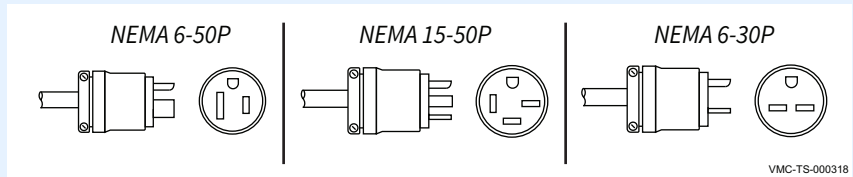

Press reset button(s)

6. **Press and release** the high limit temperature reset button(s) ②.
Remove the tag ③.

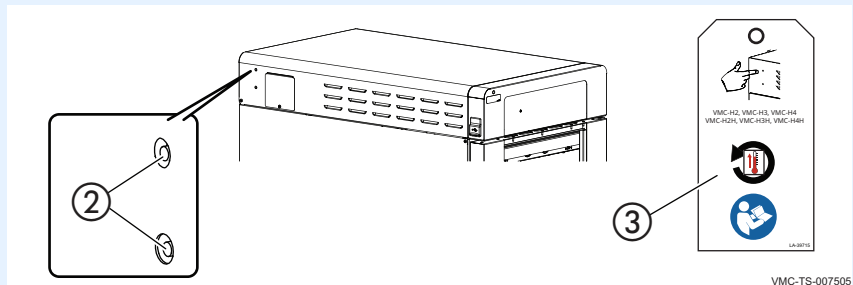

Result

The oven is now installed and ready to be used.

How to Install the Oven (60 Hz Models Without Cords or Plugs)

Before you begin

Make sure you have:

- Appropriate cord and plug. See local codes and regulations.
- Screwdriver (Phillips #2)
- Nut driver (1/4-inch)
- An appropriate lifting device, and enough personnel, to safely move and position the weight of the oven.
 - VMC-H2/H2H: 213 lb (97 kg)
 - VMC-H3/H3H: 278 lb (126 kg)
 - VMC-H4/H4H: 348 lb (158 kg)

Requirements

- The oven must be installed on a level surface.
- The oven must not be installed in any area where it may be affected by steam, grease, dripping water, high temperature, or any other severely adverse conditions.
- The oven is not intended for built-in installation.

Voltages

	V	Ph	Hz	A	Breaker*	kW
VMC-H2/ VMC-H2H	220	1	50/60	25	32	5.4
	240	1	50/60	28	32	6.4
	380	3	50/60	12	16	5.4
	415	3	50/60	13	16	6.4
VMC-H3/ VMC-H3H	220	1	50/60	37	63	8.1
	240	1	50/60	41	63	9.6
	380	3	50/60	12	16	8.1
	415	3	50/60	13	16	9.6
VMC-H4/ VMC-H4H	380	3	50/60	12	16	10.8
	415	3	50/60	13	16	12.7

*Electrical connections must meet all applicable federal, state, and local codes.

Continued on next page

Continued from previous page

Position the oven

To position the oven, do the following.

Step	Action
1.	<p>Make sure that:</p> <ul style="list-style-type: none"> The location where the oven is being installed is rated to support the weight of the oven, The oven is within five feet of the appropriate electrical outlet, You follow the oven clearance guidelines.
	
2.	<p>Move the oven to the installation location and onto the final resting surface.</p>
<p>The oven is now correctly positioned.</p>	
<h2>Level the oven</h2>	
<p>To level the oven, do the following.</p>	
3.	<p>Check the level of the oven using a spirit (bubble) level. Check front to back and side to side.</p>
	

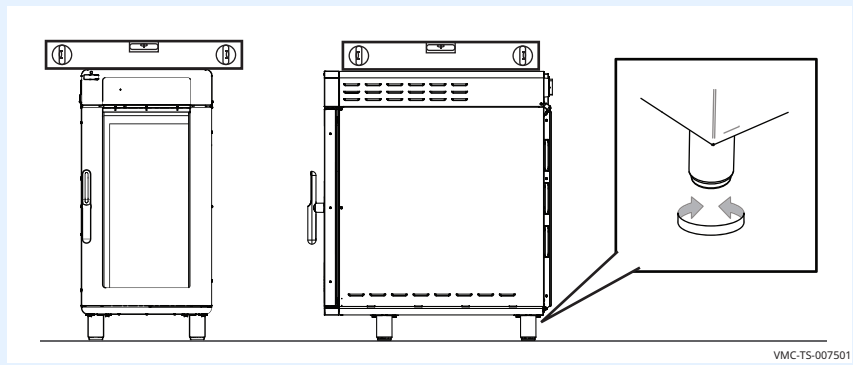
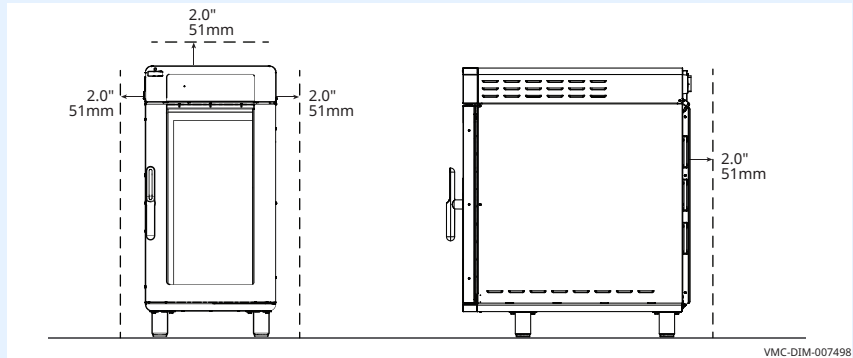

Continued on next page

Continued from previous page

Connect the wiring

To connect the wiring, do the following.

4. **Remove** the pivot screws. **Remove** the top cover ①.



WARNING: Electric shock hazard.

Make sure the supply cord is not connected to a power supply.

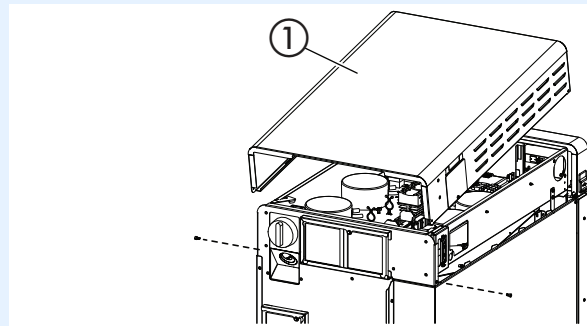

VMC-TS-007943

5. **Remove** the bottom 3 screws ② from the mounting bracket.
Remove the main disconnect switch ③ from the mounting bracket.

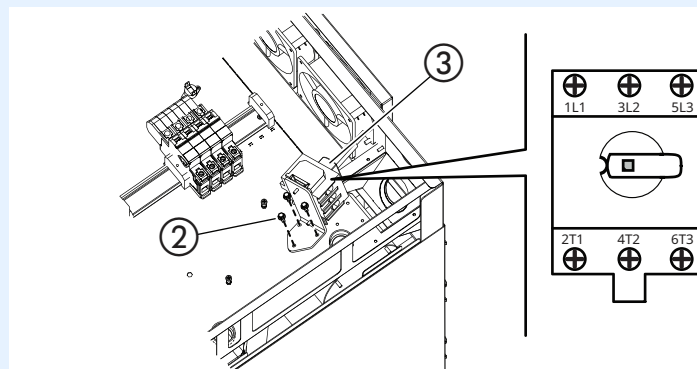

VMC-TS-001815

6. **Install** the cord ④ through the cord grip ⑤ and install to oven.
Install the lock nut onto the cord grip.

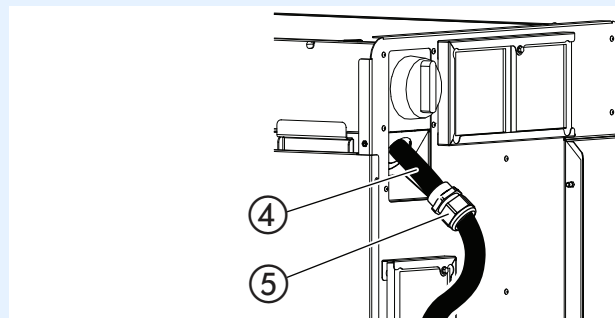

VMC-TS-007946

Continued on next page

Continued from previous page

7. **Connect** the supply cord to the appropriate terminals (L1, L2, L3, etc.) in accordance with local codes and regulations.

VMC-H2 VMC-H2H
VMC-H3 VMC-H3H

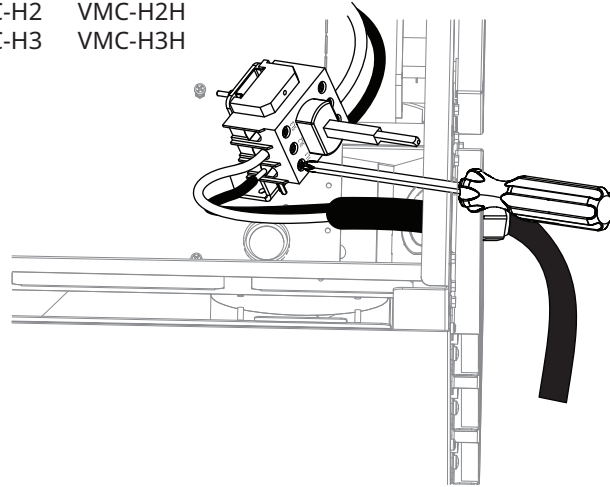

VMC-TS-001821

VMC-H3 VMC-H3H
VMC-H4 VMC-H4H

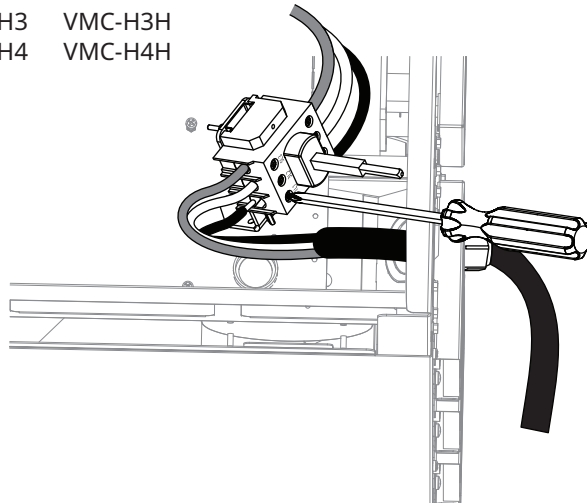

VMC-TS-001825

Continued on next page

Continued from previous page

8. **Install** the ground wire ⑥.
Adjust the cord length.
Tighten the cord grip sealing nut onto the supply cord.

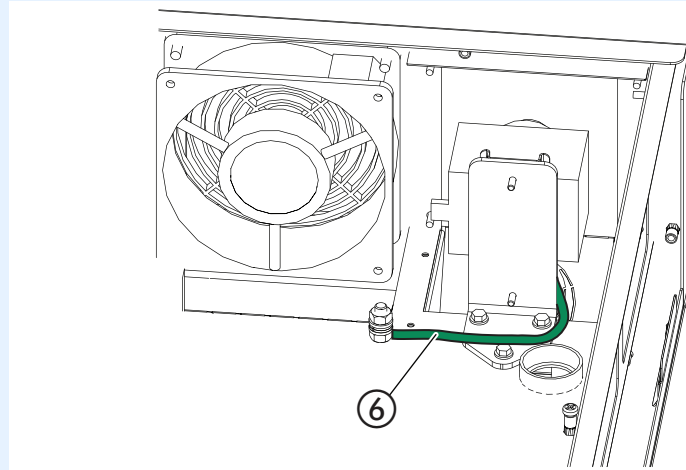

VMC-TS-001829

9. **Re-install** the main disconnect switch.
10. **Re-install** the mounting bracket.
11. **Re-install** the top cover.
12. **Press and release** the high limit temperature reset button(s) ⑦.
Remove the tag ⑧.

Press reset button(s)

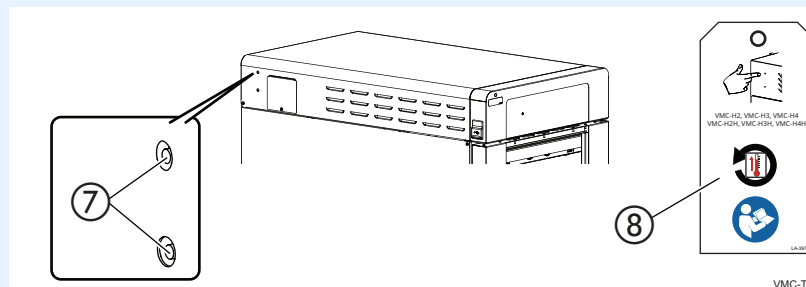

VMC-TS-007949

Result

The oven is now installed.

How to Install the Oven (50 Hz Models Without Cords or Plugs)

Before you begin

Make sure you have:

- Appropriate cord and plug, minimum oil resistant HO7RN-F. See local codes and regulations.
- Screwdriver (Phillips #2)
- Nut driver (1/4-inch)
- An appropriate lifting device, and enough personnel, to safely move and position the weight of the oven.
 - VMC-H2/H2H: 213 lb (97 kg)
 - VMC-H3/H3H: 278 lb (126 kg)
 - VMC-H4/H4H: 348 lb (158 kg)

Requirements

- The oven must be installed on a level surface.
- The oven must not be installed in any area where it may be affected by steam, grease, dripping water, high temperature, or any other severely adverse conditions.
- If required by local codes, use Type F RCD.
- The oven is not intended for built-in installation.

Voltages

	V	Ph	Hz	A	Breaker*	kW	Wire Size (mm)
VMC-H2H	220	1	50	25	32	5.4	4
	240	1	50	28	32	6.4	4
	380	3	50	12	16	5.4	1.5
	415	3	50	13	16	6.4	1.5
VMC-H3H	220	1	50	37	63	8.1	10
	240	1	50	41	63	9.6	10
	380	3	50	12	16	8.1	1.5
	415	3	50	13	16	9.6	1.5
VMC-H4H	380	3	50	23	32	10.8	4
	415	3	50	25	32	12.7	4

*Electrical connections must meet all applicable federal, state, and local codes.

Wire sizes

60335-1 IEC:2010

Rated current of appliance A	Nominal cross-sectional area mm ²
>0.2 - ≤3	0.5
>3 - ≤0	0.75
>6 - ≤10	1.0
>10 - ≤16	1.5
>16 - ≤25	2.5
>25 - ≤32	4
>32 - ≤40	6
>40 - ≤63	10

Position the oven

To position the oven, do the following.

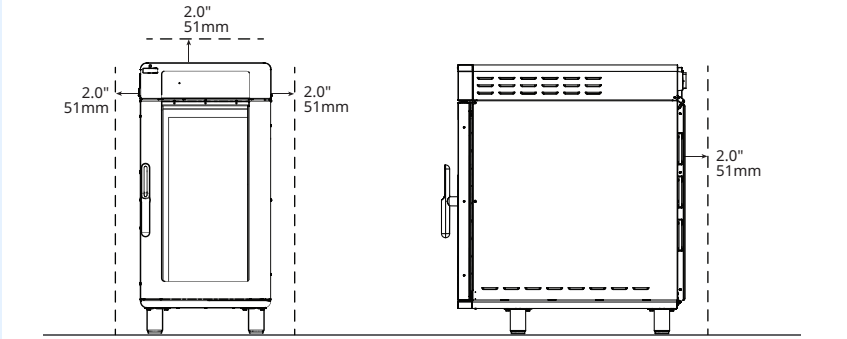
Step	Action
1.	<p>Make sure that:</p> <ul style="list-style-type: none"> ■ The location where the oven is being installed is rated to support the weight of the oven, ■ The oven is within five feet of the appropriate electrical outlet, ■ You follow the oven clearance guidelines.  <p style="text-align: right; font-size: small;">VMC-DIM-007498</p>
2.	<p>Move the oven to the installation location and onto the final resting surface.</p>

The oven is now correctly positioned.

Continued on next page

Continued from previous page

Level the oven

To level the oven, do the following.

3. **Check** the level of the oven using a spirit (bubble) level. Check front to back and side to side.

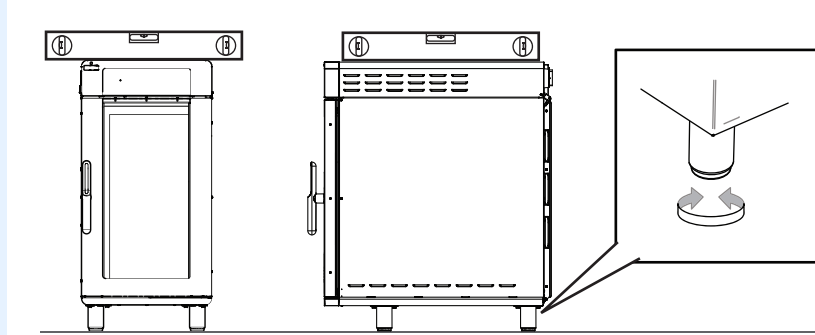

VMC-TS-007501

Adjust the legs, if necessary, to achieve levelness.

The oven is now level.

Connect the wiring

To connect the wiring, do the following.

4. **Remove** the top cover ①.



WARNING: Electric shock hazard.
Make sure the supply cord is not connected to a power supply.

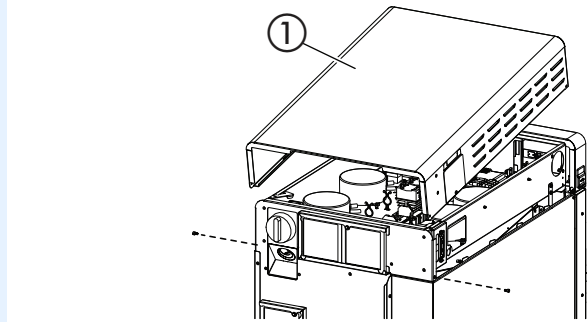

VMC-TS-007943

Continued on next page

Continued from previous page

5. **Remove** the bottom 3 screws ② from the mounting bracket.
Remove the main disconnect switch ③ from the mounting bracket.

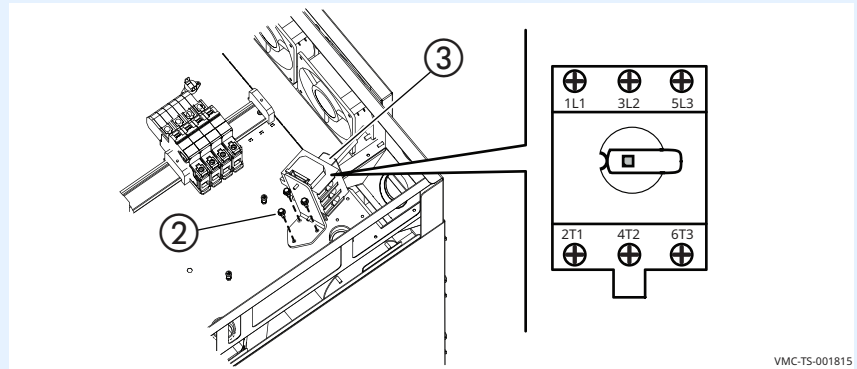

6. **Install** the cord ④ through the cord grip ⑤.
Install the cord and cord grip into the oven.
Install the lock nut onto the cord grip.

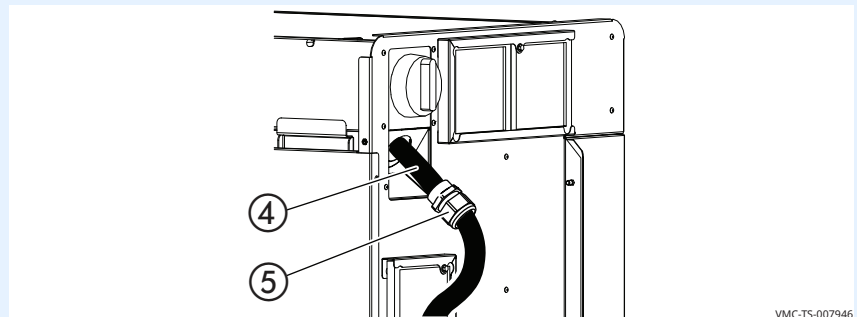

7. **Connect** the supply cord to the appropriate terminals (L1, L2, L3, etc.) in accordance with local codes and regulations.

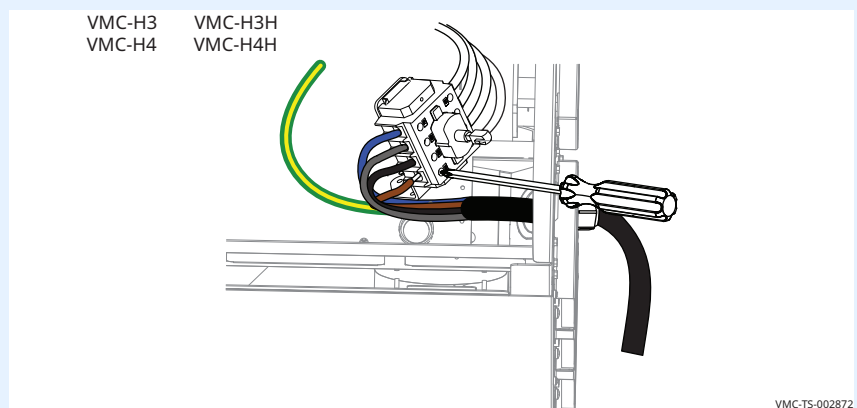

Continued on next page

Continued from previous page

8. **Install** the ground wire ⑥.

Leave an extra loop ⑦ so that current-carrying conductors become taut before the ground wire if the cord is accidentally pulled. Follow applicable regulations.

Tighten the cord grip sealing nut onto the supply cord.

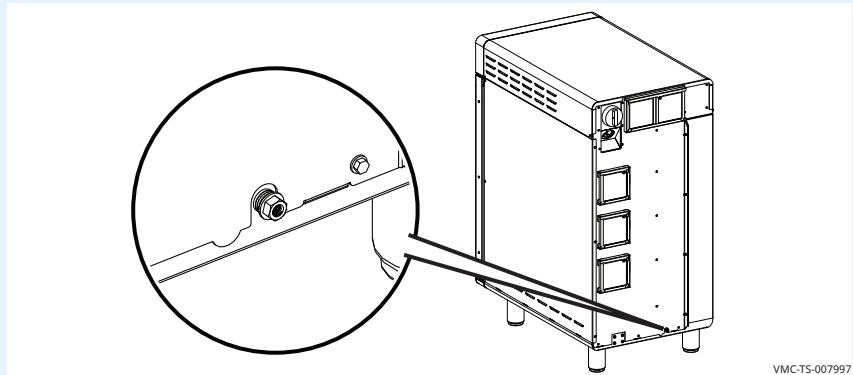
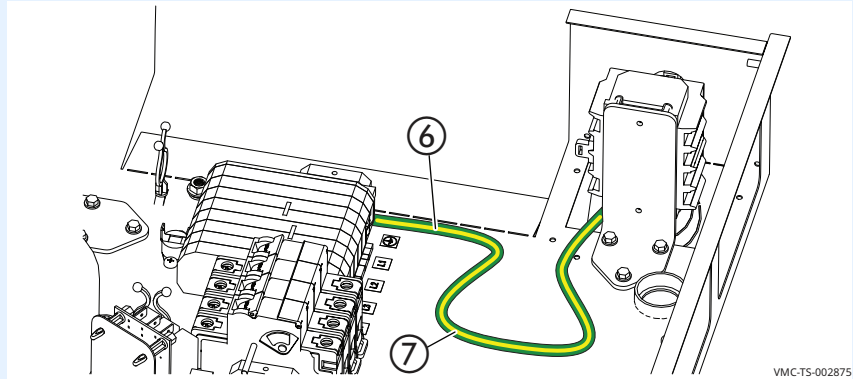

NOTE: The equipotential-bonding terminal is located at the bottom rear of the oven.

9. **Re-install** the main disconnect switch.
10. **Re-install** the mounting bracket.
11. **Re-install** the top cover.

Continued on next page

Continued from previous page

Press reset button(s)

12. **Press and release** the high limit temperature reset button(s) ⑧.
Remove the tag ⑨.

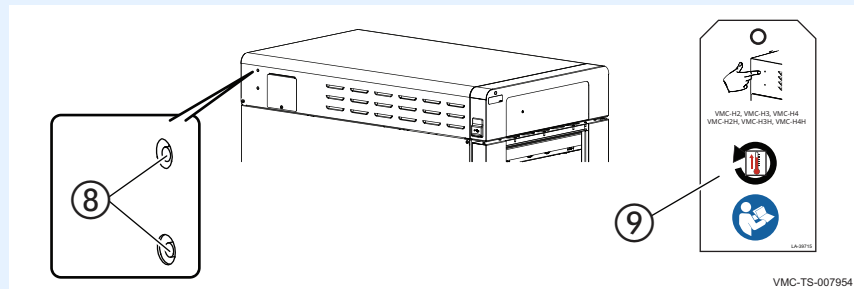

VMC-TS-007954

Result

The oven is now installed.

How to Install the Oven on a Stand

Before you begin

Make sure you have:

- The appropriate stand for your oven
- Regulation UL 197, 91.8
- An appropriate lifting device, and enough personnel, to safely move and position the weight of the oven.
 - VMC-H2/H2H: 213 lb (97 kg)
 - VMC-H3/H3H: 278 lb (126 kg)
 - VMC-H4/H4H: 348 lb (158 kg)

Procedure

To install the ovens, do the following.

Step	Action
1.	Remove the feet ①.
2.	Lift the oven and set it on the stand.
3.	Connect the oven to the stand with the supplied fasteners ②.

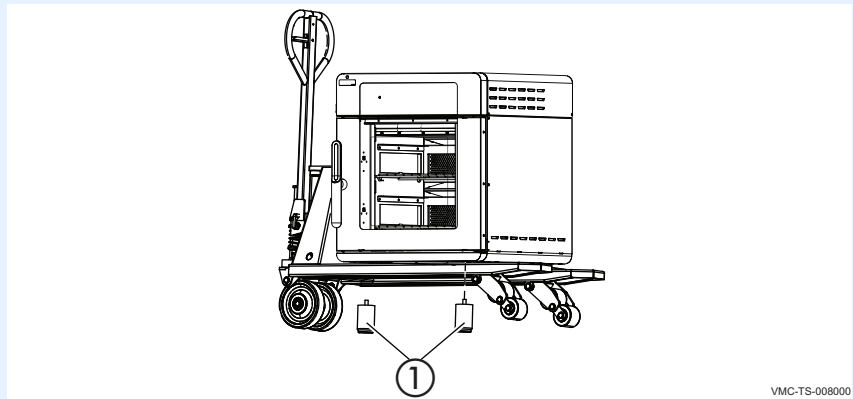

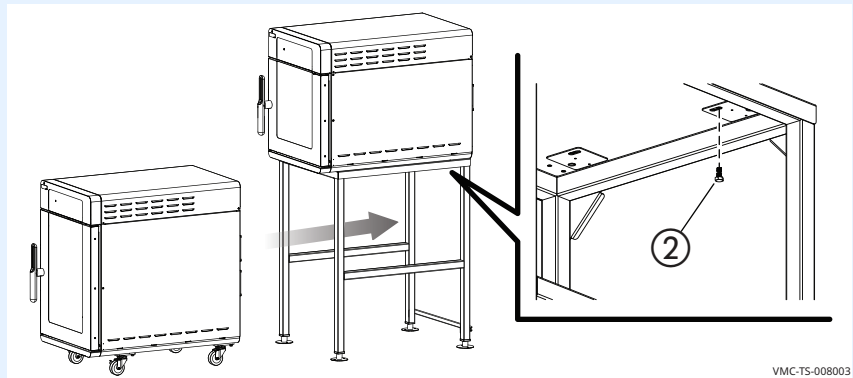

Continued on next page

Continued from previous page

Install wheels on lower oven

To install the casters on the lower oven, do the following.

4. **Attach** each caster with fasteners as shown.

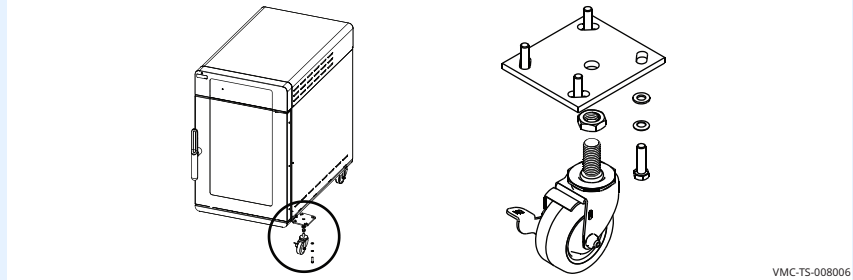

5. **Level** the unit as necessary. To do so, screw the wheel up or down until the unit is level. Tighten the jam nut (3).

Slide a piece of the tubing (4) over the exposed screws if more than 1/4-inch of thread is exposed.

Attach wire tie (5) around the tubing to hold it in place.

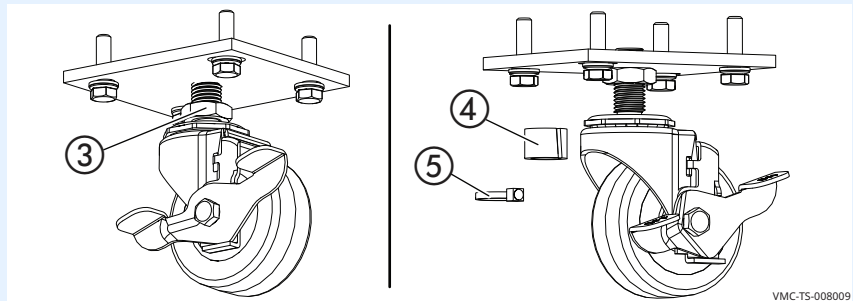

Install the tether

6. **Install** the tether to the lower oven. Install the tether so that no stress is transmitted to the electrical cord when the oven moves.

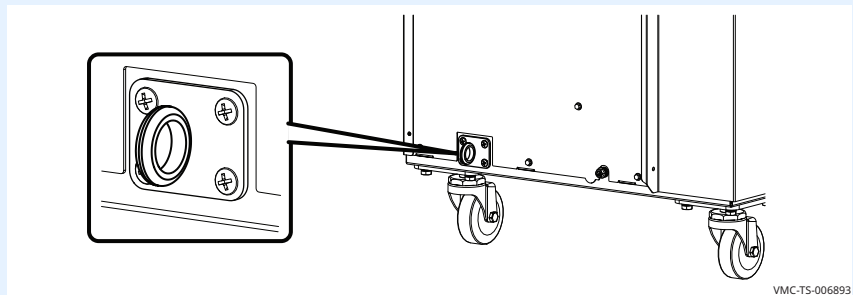

Result

The oven is now installed to the stand.

This page intentionally left blank.

How to Turn On and Turn Off the Oven

Before you begin

The oven must be connected to electric power.

Turning on the oven

To turn on the oven, do the following.

Step	Action
1.	<p>Set the main disconnect switch ① to the ON position.</p> <p>Press the ON/OFF button ②. The LED on the button illuminates green.</p>
<p>NOTE: The main disconnect switch is meant to be used during cleaning or service operations. For every day operation, it may be left in the ON position.</p>	
	

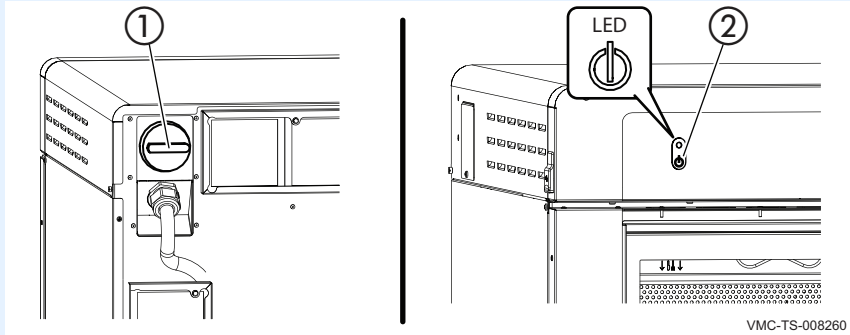

The oven is now on.

Turning off the oven

To turn off the oven, do the following.

2. **Press and hold** the ON/OFF button until the LED above the ON/OFF button illuminates red.

The oven activates the blowers for the cool down process. The screen displays a cool down prompt and asks for the door to be opened. The oven will deactivate the blowers when the cool down process is complete.

The oven is now off.

How to Set Preheat Temperatures

Before you begin

- The oven must be turned on (screen is on).
- Factory preset preheat temperature for each chamber is 350°F.
- You will need to know the pass code. The pass code set at the factory is 12345.

Procedure

To set the preheat temperatures, do the following.

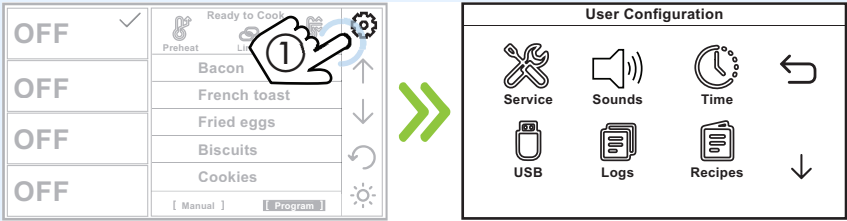
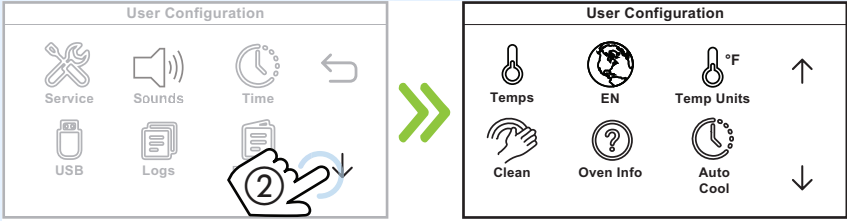
Step	Action
1.	<p>Touch the gear icon ①. The first User Configuration screen displays.</p>  <p style="text-align: right; font-size: small;">VMC-TS-007669</p>
2.	<p>Touch the down arrow ②. The second User Configuration screen displays.</p>  <p style="text-align: right; font-size: small;">VMC-TS-007750</p>

Continued on next page

Continued from previous page

3. **Touch** the Temps icon ③. The Enter Pass Code screen displays.
Enter the pass code 12345.

Touch the check mark. The Set Preheat Temperatures screen displays.

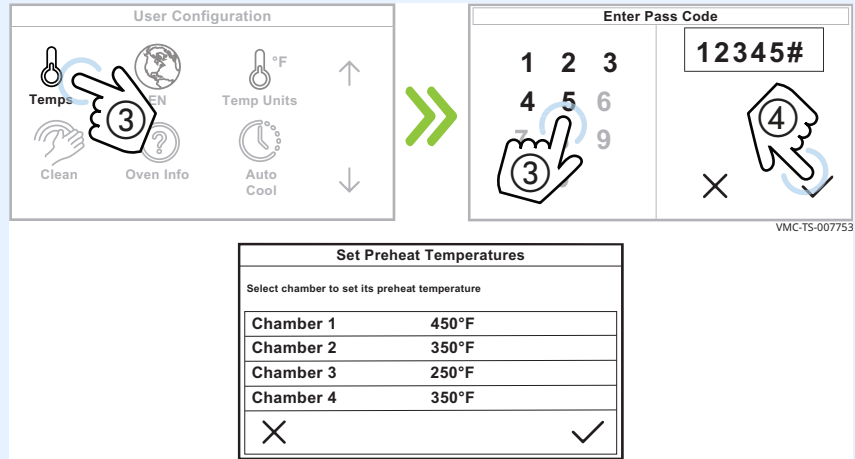

4. **Touch** the chamber ④. The existing temperature displays. **Enter** the cooking temperature using the number pad. **Touch** the check mark.

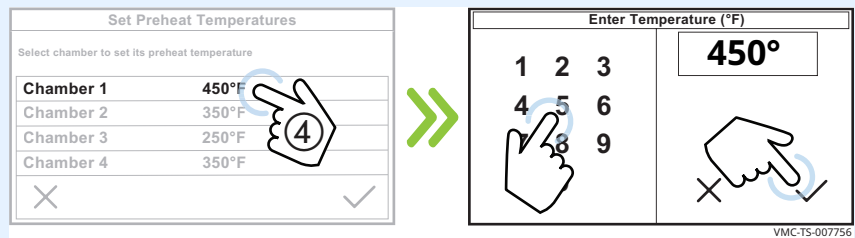

5. **Repeat** the process for the other chambers if desired.

NOTE: Each chamber's temperature can differ from the next chamber by 100°F. Set the highest cooking temperature in the top chamber (chamber 1).

6. **Touch** the check mark ⑤.

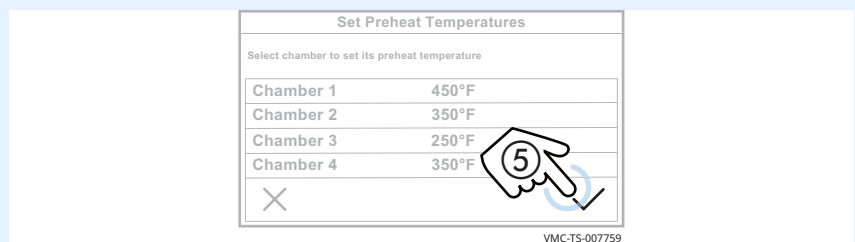

Continued on next page

Continued from previous page

7. **Touch** the up arrow ⑥ then the back arrow ⑦ to return to the home screen.

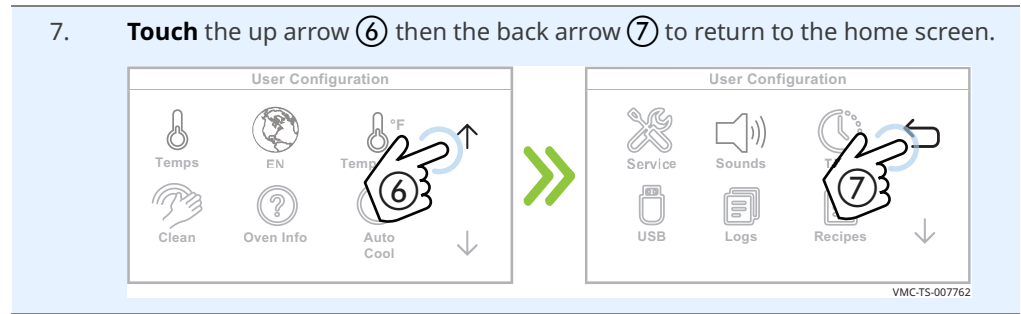

Result

The preheat temperatures have now been set.

How to Preheat the Oven

Before you begin

- The oven must be connected to electric power.
- The oven chambers should be empty.

All chambers simultaneously

To preheat all chambers simultaneously, do the following.

Step	Action
------	--------

1. **Touch** the Preheat icon ①. All chambers start to preheat to their preset temperatures.

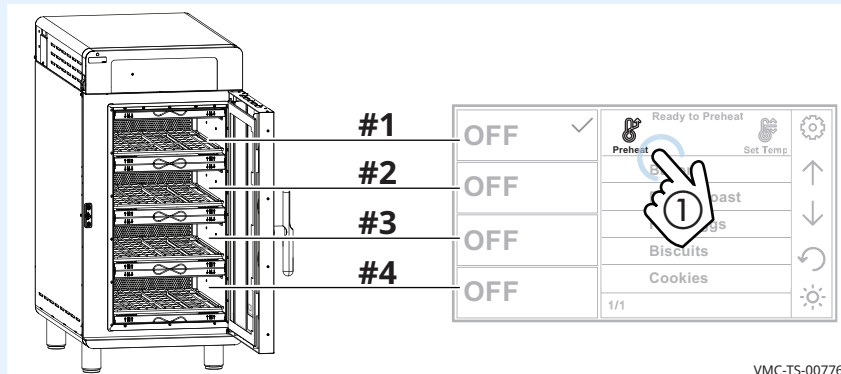

VMC-TS-007765

To preheat individual chambers separately, continue.

Individual chambers separately

2. **Touch** the chamber icon ②. The check mark signifies the chosen chamber.

NOTE: The Set Temp function must be enabled. See topic How to Enable Manual Mode, Linking, and Set Temp Function.

Touch the Set Temp icon ③. The Enter Temperature screen displays.

Enter the temperature ④ using the number pad.

Touch the check mark ⑤. The oven starts the preheat process.

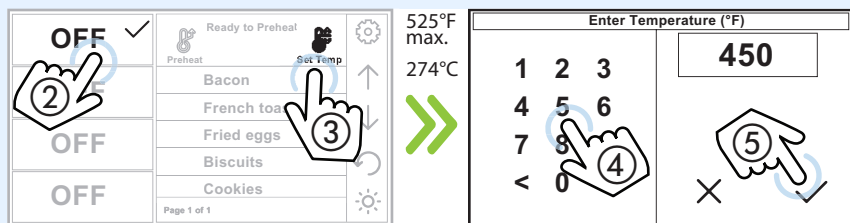

VMC-TS-007768

Continued on next page

Continued from previous page

Screen loading bars

On the left side of the screen, red screen loading bars indicate each chamber's progress towards reaching its set temperature.

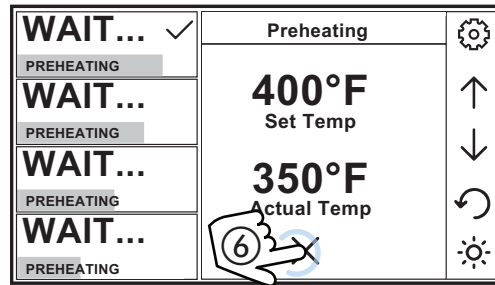

The screen displays the chamber's actual temperature and its set temperature. Selecting different chambers displays information on their respective temperatures.

Touch the cancel icon (6) to cancel the preheating process before the individual chamber reaches its preset preheat temperature. Each chamber must be canceled individually.

Length of time to preheat

It takes approximately 10-15 minutes (dependent upon the set temperature) for the oven to reach temperature.

As each chamber reaches its set temperature, it starts a countdown from 5 minutes to let the temperature stabilize. After that, the screen displays READY to indicate that the chamber is ready for cooking.

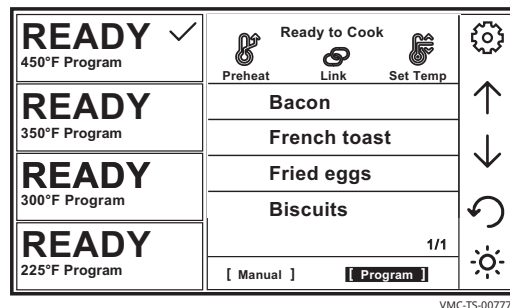

Result

The oven is now ready for cooking.

How to Cook in Manual Mode

Before you begin

- Be sure the oven is warmed up. Refer to topic How to Preheat the Oven.
- The Manual function must be enabled. See topic How to Enable Manual Mode, Linking, and Set Temp Function.
- Be sure your food is prepared and ready to cook.

Procedure

To cook in manual mode, do the following.

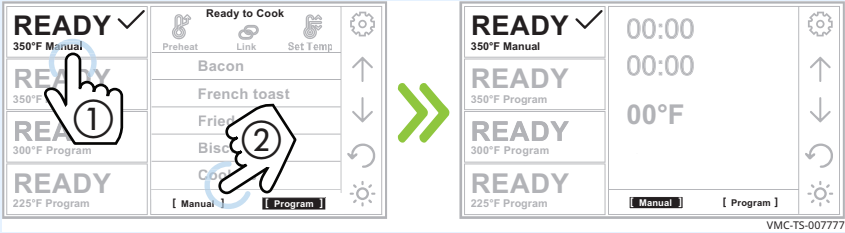
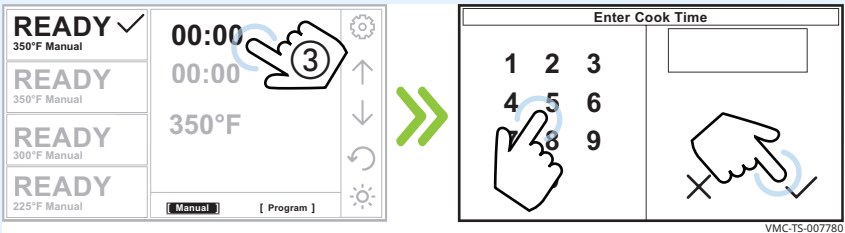
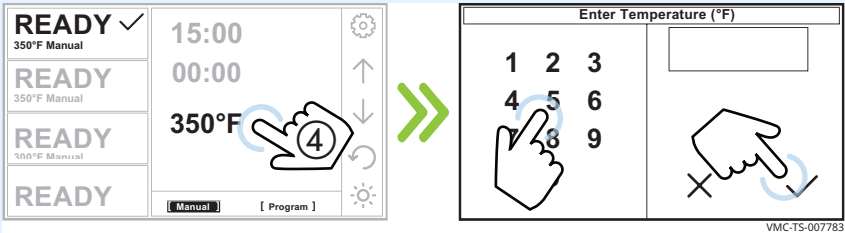
Step	Action
1.	<p>Touch the chamber ①. The check mark signifies the chosen chamber.</p> <p>Touch Manual ②. The manual mode screen displays.</p>  <p>VMC-TS-007777</p>
2.	<p>Touch the time setting ③. Enter the cooking time using the number pad. Touch the check mark.</p>  <p>VMC-TS-007780</p>
3.	<p>Touch the temperature setting ④. Enter the cooking temperature using the number pad. Touch the check mark.</p>  <p>VMC-TS-007783</p>
	<p>NOTE: If entering a cooking temperature that differs from the preheat temperature, let the oven adjust to the cooking temperature before loading the oven.</p>

Continued on next page

Continued from previous page

4. **Touch** Air Speed ⑤. **Enter** the air flow in percentage 10%–100% using the number pad. **Touch** the check mark.

NOTE: The Air Speed icon will flash until a value is entered. You must enter values for time, temperature, and air speed.

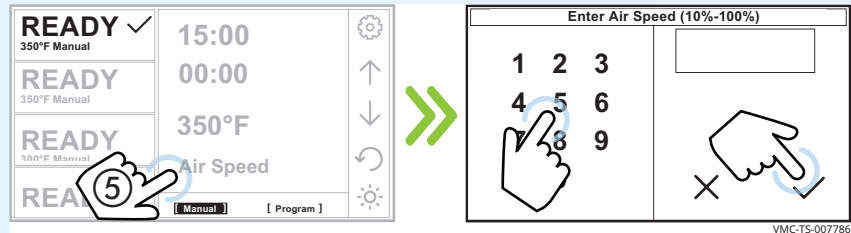

5. **Load** the food into the oven.

NOTE: The oven will not start cooking with the door open.

6. **Touch** the start icon ⑥. The timer starts counting. Pressing the X icon ⑦ stops the timer. The timer resets to 0.

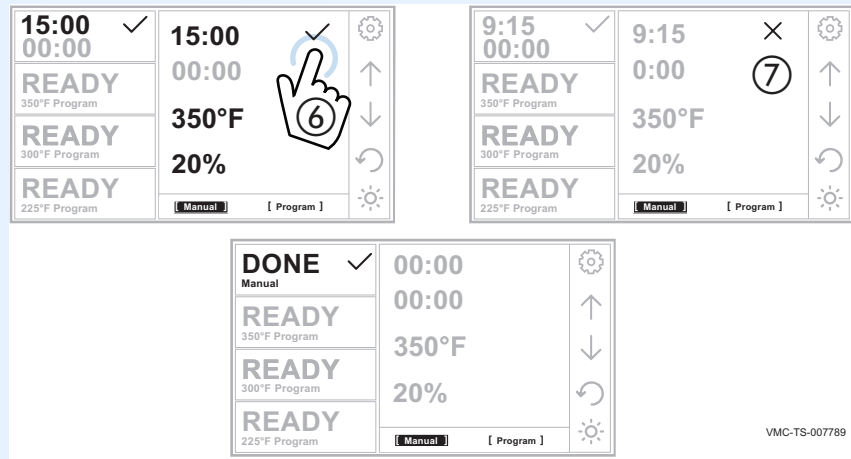

NOTE: Cooking time and air speed may be adjusted any time during the cooking cycle. The timer stops when the door is open, and resumes when the door is closed.

At the end of the cooking process, the oven sounds an alert and the chamber light flashes. The DONE screen displays.

7. **Open** the door and remove the hot food.

Result

The food is now cooked.

How to Use the Dual Timers

Before you begin

- Refer to topic How to Cook in Manual Mode

Background

There may be times when you will want to use the same chamber to cook two pans of food at the same time, but at different intervals. The dual timer function allows you to do so.

Procedure

To cook using the dual timers, do the following.

Step Action

1. **Touch** the chamber ①. The check mark signifies the chosen chamber. **Touch** Manual ②. The manual mode screen displays.

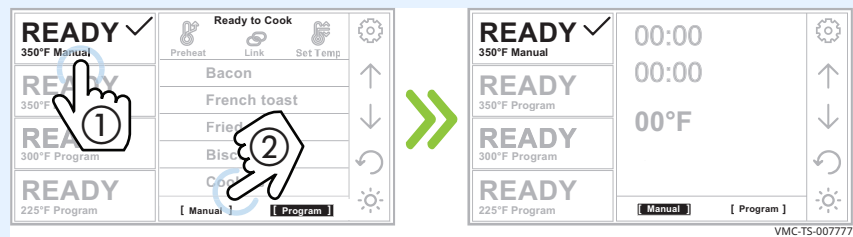

2. **Touch** the time setting ③. **Enter** the cooking time using the number pad. **Touch** the check mark.

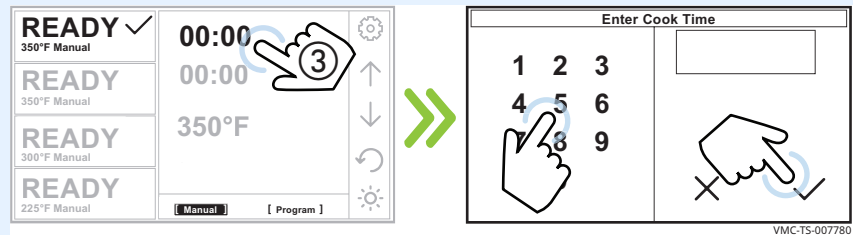

3. **Enter** the time ④ for the second pan of food.

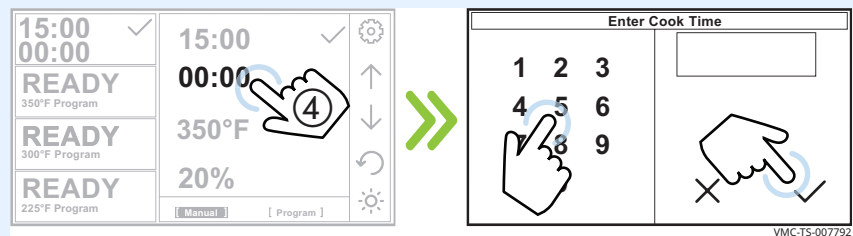

Continued on next page

Continued from previous page

4. **Touch** the temperature setting ⑤. **Enter** the cooking temperature using the number pad. **Touch** the check mark.

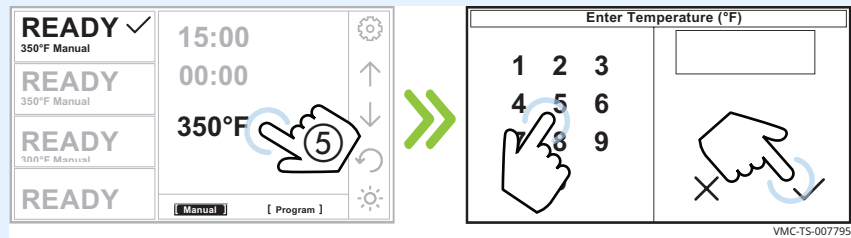

NOTE: If entering a cooking temperature that differs from the preheat temperature, let the oven adjust to the cooking temperature before loading the oven.

5. **Touch** Air Speed ⑥. **Enter** the air flow in percentage 10-100% using the number pad. **Touch** the check mark.

NOTE: The Air Speed icon will flash until a value is entered. You must enter values for time, temperature, and air speed.

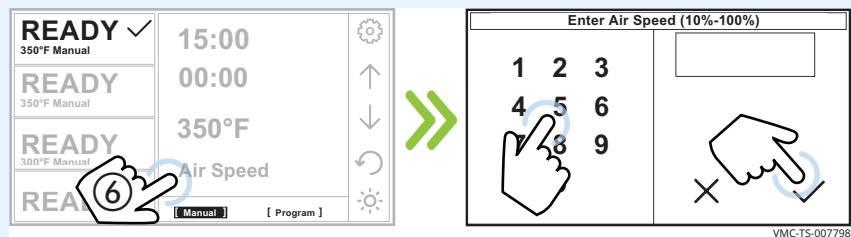

6. **Open** the door and load pan 1. **Close** the door. **Touch** the start icon ⑦. The timer for pan 1 will start counting.

NOTE: The oven will not start cooking with the door open.

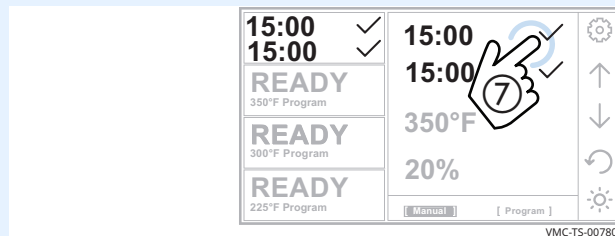

Continued on next page

Continued from previous page

7. **Open** the door and load pan 2 when it is ready. **Close** the door. **Touch** the start icon (8). The timer for pan 2 will start counting. **Pressing** the X icon (9) stops the timer. The timer resets to 0.



NOTE: The oven will not start cooking with the door open.

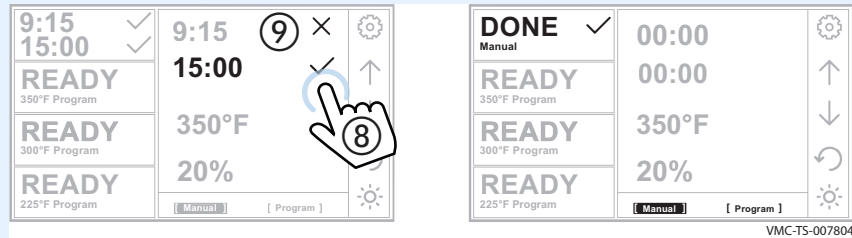

At the end of the cooking process, the oven sounds an alert and the chamber light flashes. The DONE screen displays.

8. **Open** the door and remove the hot food.

Result

The food is now cooked.

How to Cook with Programmed Recipes

Before you begin

- Be sure the oven is preheated
- Be sure your food is prepared and ready to cook

Procedure

To cook using a programmed recipe, do the following.

Step	Action
------	--------

- | | |
|----|--|
| 1. | Select the chamber ①. The check mark indicates the chosen chamber.
Touch Program ②. |
|----|--|

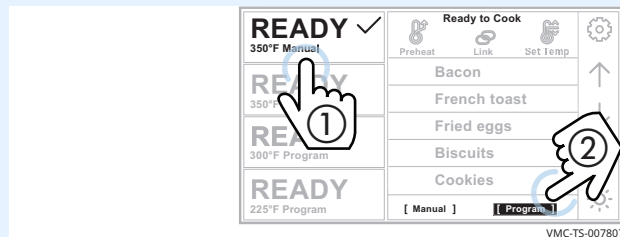

- | | |
|----|--|
| 2. | Navigate to the recipe using the arrows ③. Recipes are sorted first by set temperature and then alphabetically. |
|----|--|

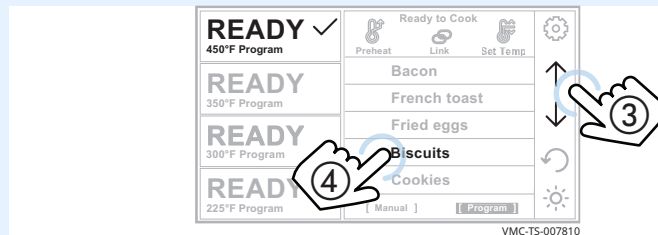

NOTE: If the recipe is highlighted in red, it means that the item cannot be cooked at the chamber's current set temperature. Selecting a recipe highlighted in red will start a preheat or cool-down cycle to adjust the temperature to that of the selected recipe.

- | | |
|----|---|
| 3. | Open the door and load the food into the selected chamber.
Close the door. |
|----|---|

NOTE: The oven will not start cooking with the door open.

- | | |
|----|---|
| 4. | Touch the recipe ④. The oven starts cooking. |
|----|---|

Continued on next page

Continued from previous page

During the cooking process

The screen indicates the time remaining.

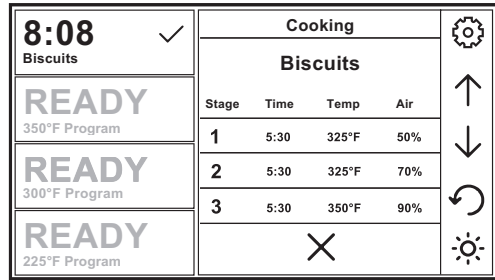

VMC-TS-007813

- The menu area displays details on the current cook setting.
- Touching the cancel icon stops the cooking process.

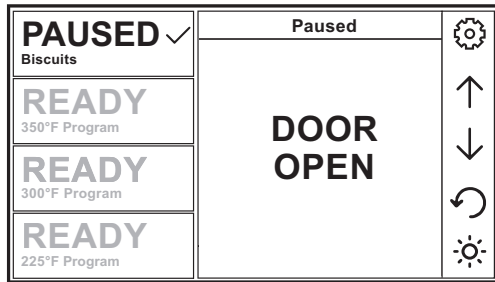

VMC-TS-007816

Switch to another chamber to cook another product.

Result

At the end of the cooking process, the oven sounds an alert and the chamber light flashes. The DONE screen displays.

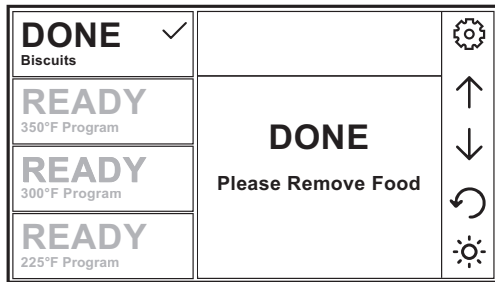

VMC-TS-007819

How to Cook with Linked Chambers

Before you begin

- The selected chambers must be warmed up to the temperature of the recipe. Refer to topic How to Preheat the Oven.
- The Link function must be enabled. See topic How to Enable Manual Mode, Linking, and Set Temp Function.
- The oven must be in Program mode.

Linking chambers

To link chambers, do the following.

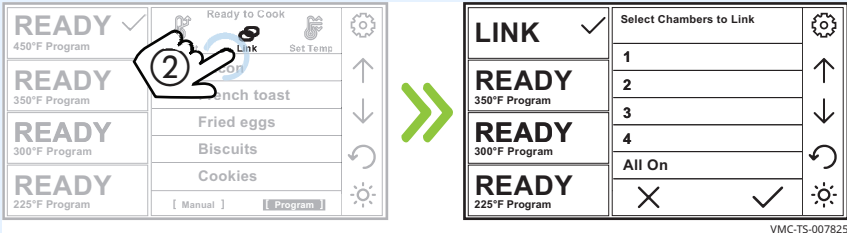
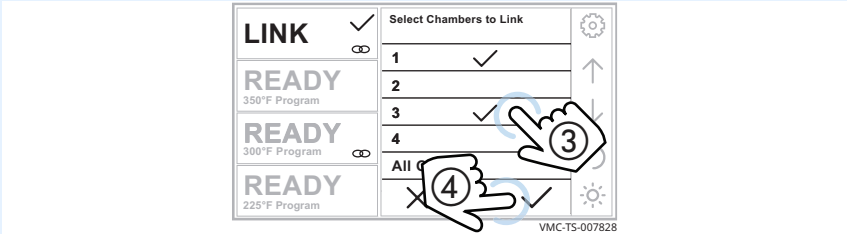
Step	Action
1.	<p>Touch the Program icon ①.</p> 
2.	<p>Touch the Link icon ②. The linking screen displays.</p> 
3.	<p>Touch the chambers ③ you want to link. Touch the check mark ④.</p> <p>NOTE: Pressing All On selects all chambers. Chambers with a ∞ icon are linked</p> 

Result

The chambers are now linked.

Continued on next page

Continued from previous page

Cooking with linked chambers

To cook with linked chambers, do the following.

4. **Navigate** to the recipe using the arrow icons (5).

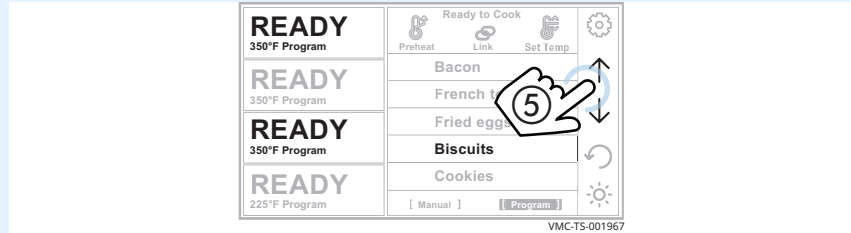

5. **Open** the door and load the selected chambers.

6. **Touch** the recipe (6). The Cooking screen displays and the cooking process starts.

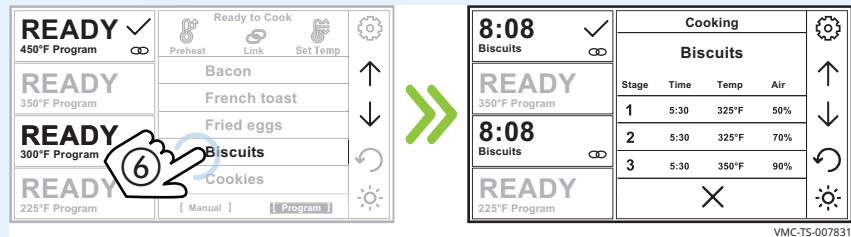

Result

At the end of the cooking process, the oven sounds an alert and the chamber light flashes. The DONE screen displays.

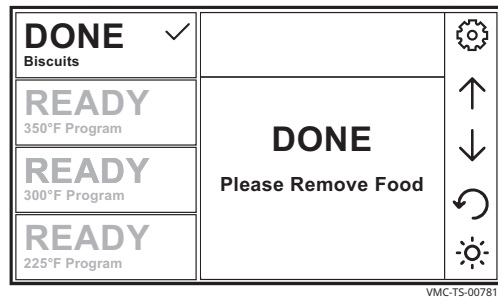

How to Create and Edit Recipes

Before you begin

You will need to know the pass code. The pass code set at the factory is 12345.

Procedure

To create or edit a recipe, do the following.

Step Action

1. **Touch** the gear icon ①. The User Configuration screen displays.

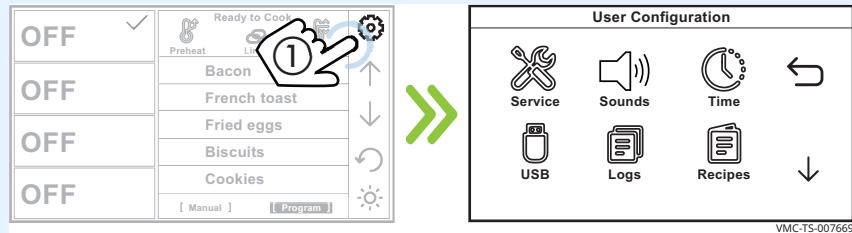

2. **Touch** the Recipes icon ②. The Enter Pass Code screen displays.
Enter the pass code 12345 ③.
Touch the check mark ④. The Recipes screen displays.

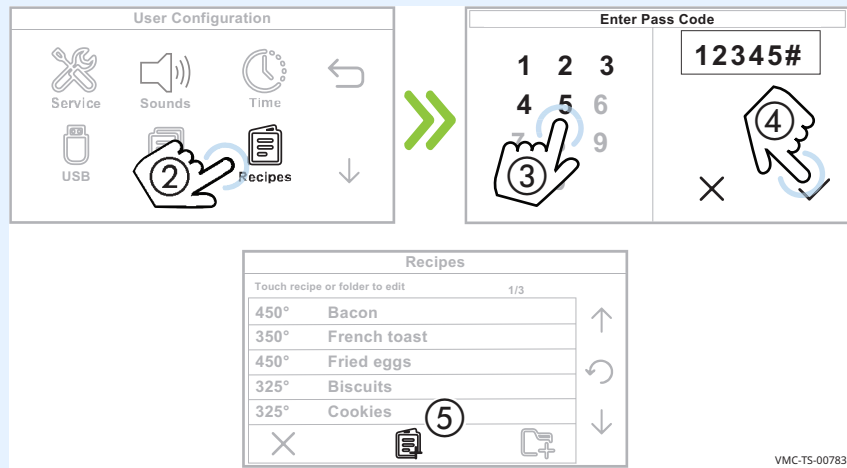

From the Recipes screen you can browse existing recipes or create a new recipe. Touching an existing recipe allows you to edit it. Touching the new recipe icon ⑤ creates a new recipe.

Continued on next page

Continued from previous page

3. **Touching** the new recipe icon or touching an existing recipe allows access to the following:
 - Recipe name
 - Temperature for each stage
 - Time for each stage
 - Air speed for each stage
 - Number of stages (By default, stages 2 and 3 have a length of zero.)

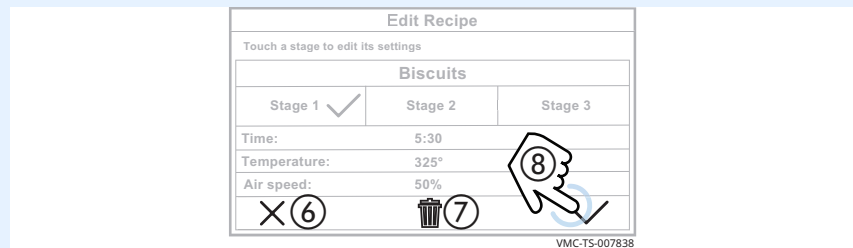

Touching the cancel icon ⑥ discards any changes.

Touching the delete icon ⑦ deletes the recipe. This is only available on existing recipes.

4. **Touch** the check mark icon ⑧ when finished to save the recipe.

Result

The procedure is now complete.

How to Create and Edit Recipe Folders

Before you begin

You will need to know the pass code. The pass code set at the factory is 12345.

Procedure

To create or edit a recipe folder, do the following.

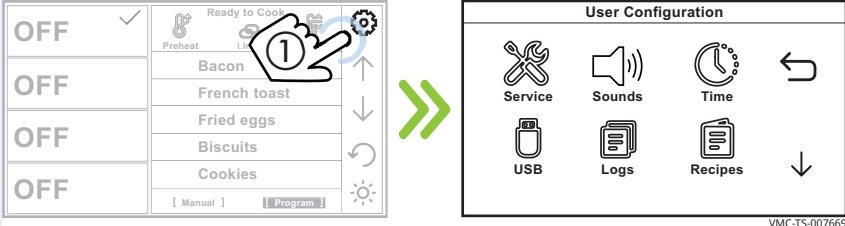
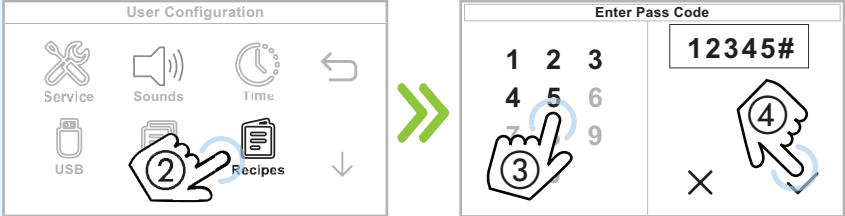
Step	Action
1.	<p>Touch the gear icon ①. The User Configuration screen displays.</p>  <p>The 'User Configuration' screen displays options: Service, Sounds, Time, USB, Logs, and Recipes. A hand icon with a '4' points to the Recipes icon.</p>
2.	<p>Touch the Recipes icon ②. The Enter Pass Code screen displays.</p> <p>Enter the pass code 12345 ③.</p> <p>Touch the check mark ④. The Recipes screen displays.</p>  <p>The 'Recipes' screen displays a list of recipe folders: Bacon, French toast, Fried eggs, Biscuits, and Cookies. A hand icon with a '5' points to the 'New Folder' icon at the bottom.</p>

From the Recipes screen you can browse existing recipe folders or create a new recipe folder. Touching an existing recipe folder allows you to edit it. Touching the new folder icon ⑤ creates a new folder.

Continued on next page

Continued from previous page

3. **Create** a new folder or **edit** an existing folder.

Touch the recipes you want to add to the folder.

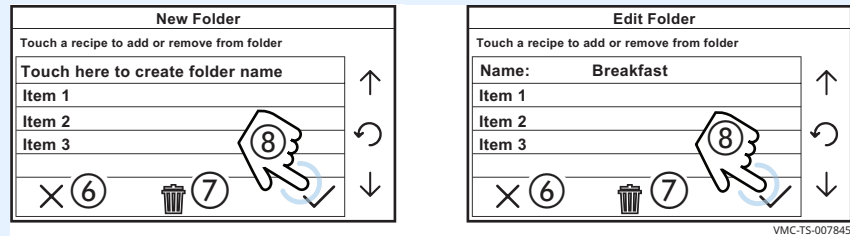

Touching the cancel icon (6) discards any changes.

Touching the delete icon (7) deletes the folder.

4. **Touch** the check mark icon (8) when finished to save the folder.

Result

The procedure is now complete.

How to Load Recipes from a USB Drive

Before you begin

- You will need a USB drive loaded with recipes.
- You will need to know the pass code. The pass code set at the factory is 12345.

Procedure

To load recipes from the USB drive, do the following.

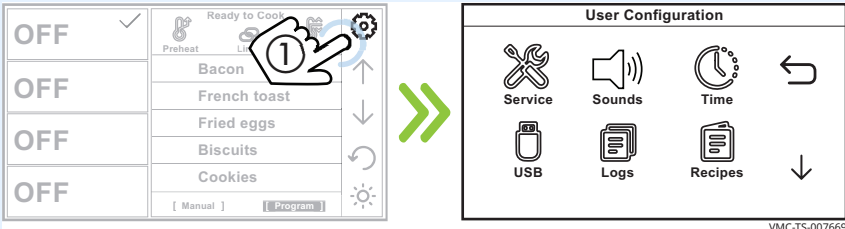
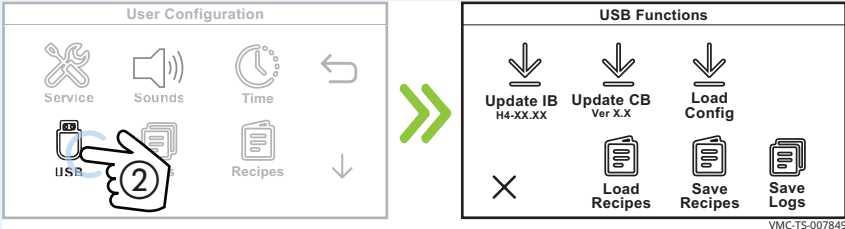
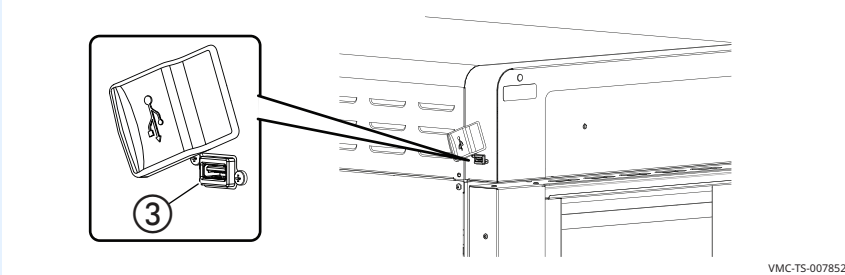
Step	Action
1.	<p>Touch the gear icon ①. The User Configuration screen displays.</p>  <p style="text-align: right; font-size: small;">VMC-TS-007669</p>
2.	<p>Touch the USB icon ②. The USB Functions screen displays.</p>  <p style="text-align: right; font-size: small;">VMC-TS-007849</p>
3.	<p>Plug the USB drive into the port ③.</p>  <p style="text-align: right; font-size: small;">VMC-TS-007852</p>

Continued on next page

Continued from previous page

4. **Touch** Load Recipes ④. The Enter Pass Code screen displays.
Enter the pass code 12345 ⑤.
Touch the check mark ⑥.

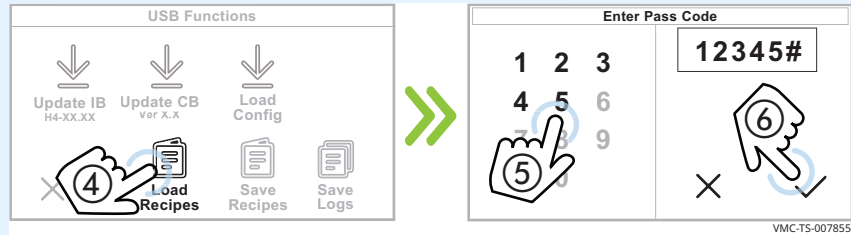

5. **Touch** the recipe file ⑦.

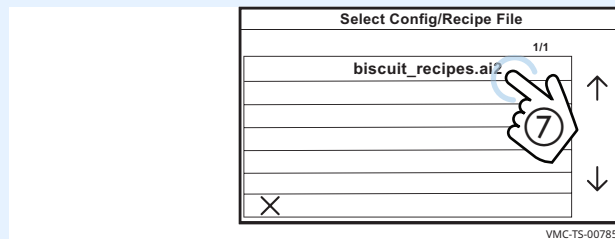

Loading/reading the recipes

The oven loads the selected config file (recipe). The Loading Config File screen displays.

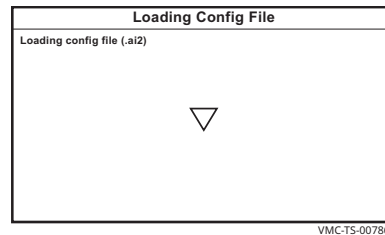

The oven turns off after the recipes are loaded.

Result

The recipes are now loaded.

How to Save Recipes to a USB Drive

Before you begin

- You will need a USB drive.
- You will need to know the pass code. The pass code set at the factory is 12345.

Procedure

To download recipes from the oven to a USB drive, do the following.

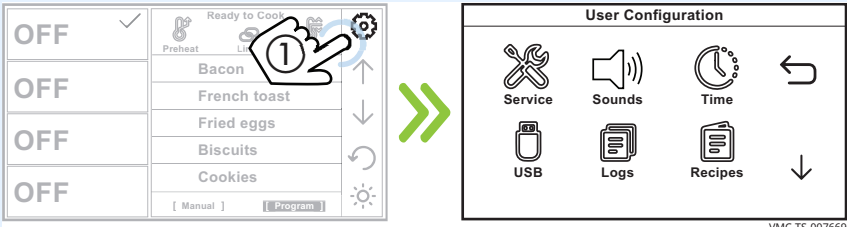
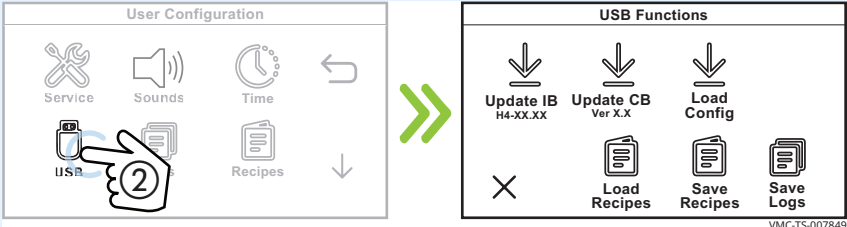
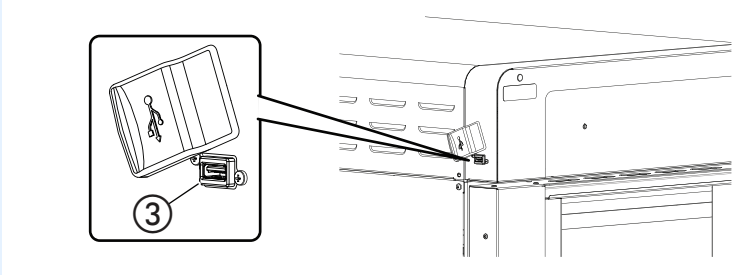
Step	Action
1.	<p>Touch the gear icon ①. The User Configuration screen displays.</p> 
2.	<p>Touch the USB icon ②. The USB Functions screen displays.</p> 
3.	<p>Plug the USB drive into the port ③.</p> 

Continued on next page

Continued from previous page

4. **Touch** Save Recipes (4). The Enter Pass Code screen displays. **Enter** the pass code 12345 (5). **Touch** the check mark (6).

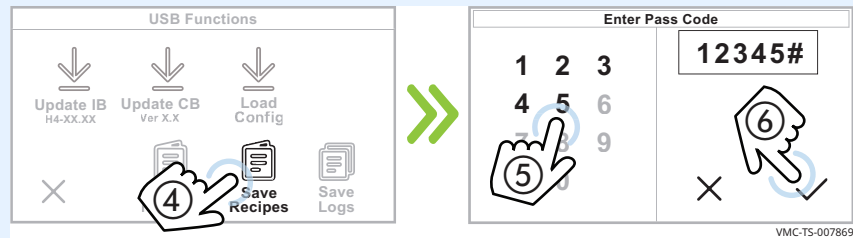

The oven downloads the recipes onto the USB drive. The default name for the file generated is ui_dump.ai2. If another file with the same name is present, the oven will add numbers after the name so that no file is overwritten: ui_dump1.ai2, ui_dump2.ai2, ui_dump3.ai2 and so on.



The Saving Recipes screen displays during the saving process. When the process is complete, the USB Functions screen displays.

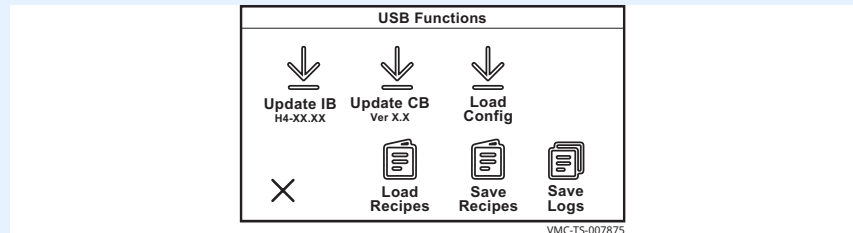

5. **Touch** the cancel icon (7) then the back arrow (8) to return to the home screen.

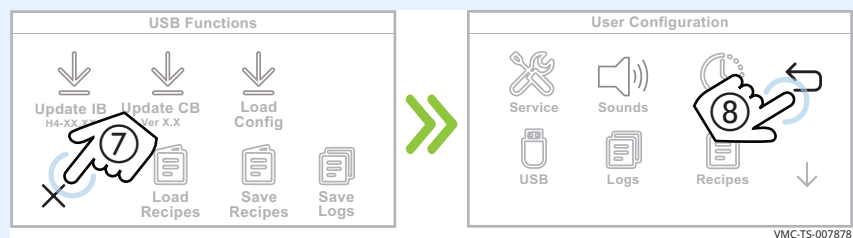

6. **Remove** the USB drive.

Result

The recipes are now saved to the USB drive.

How to Turn On and Turn Off the Chambers

Before you begin

The oven must be connected to electric power.

Turning off a chamber

To turn off a chamber, do the following.

Step	Action
------	--------

1. **Touch and hold** the chamber icon ①. The chamber displays OFF.

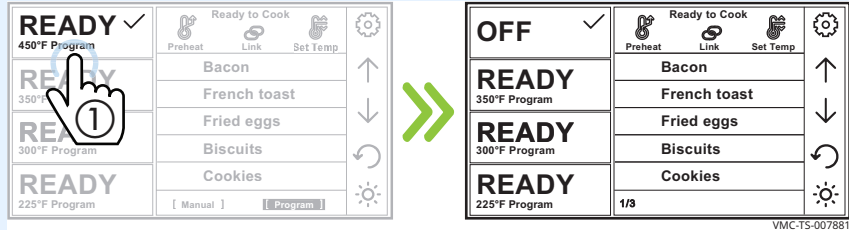

2. **Repeat** the process for other chambers.

The chamber is now off.

Turning on a chamber

To turn on a chamber, do the following.

3. **Touch** the chamber icon ②. The check mark signifies the chosen chamber.
Touch the Set Temp icon ③. The Enter Temperature screen displays.
Enter the temperature ④ using the number pad.
Touch the check mark ⑤. The chamber turns on.

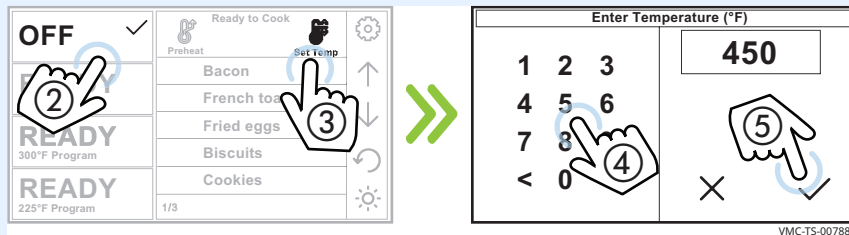

The chamber is now on.

How to Enable Auto Cool

Before you begin

- The oven must be turned on (screen is on).
- You will need to know the pass code. The pass code set at the factory is 12345.

Background

There may be times when you want the oven to automatically cool down at a set time. The Auto Cool function allows you to do so.

Procedure

To enable Auto Cool, do the following.

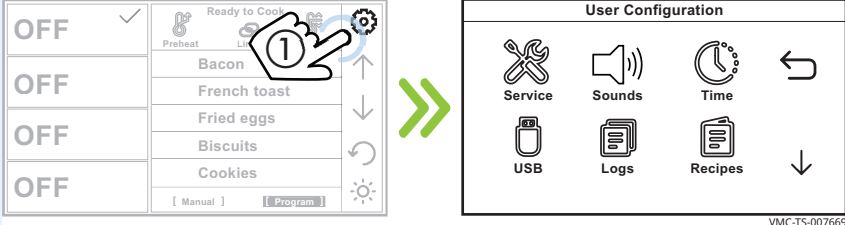
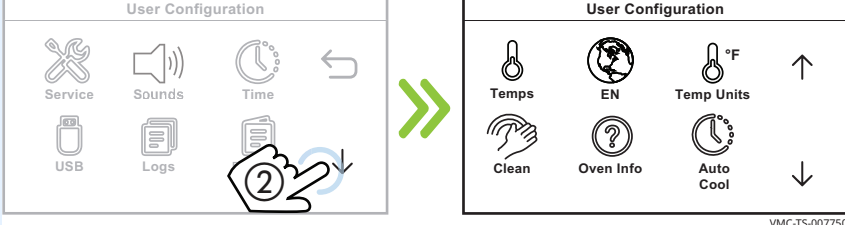
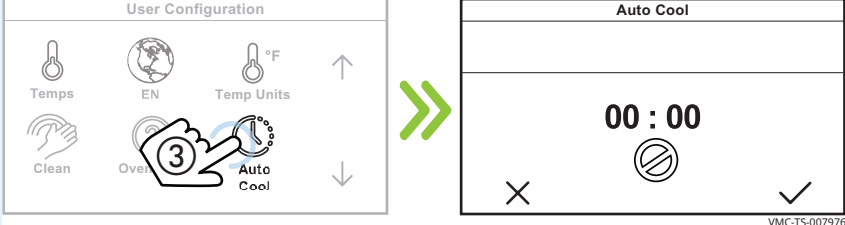
Step	Action
1.	<p>Touch the gear icon ①. The User Configuration screen displays.</p>  <p>The first screenshot shows the 'Ready to Cook' screen with a gear icon circled in red and labeled '1'. A hand icon points to it. A green arrow points to the second screenshot, which shows the 'User Configuration' screen with options: Service, Sounds, Time, USB, Logs, and Recipes. A hand icon points to the 'Time' option.</p> <p style="text-align: right; font-size: small;">VMC-TS-007669</p>
2.	<p>Touch the down arrow ②. The second User Configuration screen displays.</p>  <p>The second screenshot shows the 'User Configuration' screen with options: Service, Sounds, Time, USB, Logs, and a down arrow circled in red and labeled '2'. A hand icon points to it. A green arrow points to the third screenshot, which shows the 'User Configuration' screen with options: Temps, EN, Temp Units, Clean, Oven Info, and Auto Cool. A hand icon points to the 'Auto Cool' option.</p> <p style="text-align: right; font-size: small;">VMC-TS-007750</p>
3.	<p>Touch the Auto Cool icon ③. The Auto Cool screen displays.</p>  <p>The third screenshot shows the 'User Configuration' screen with options: Temps, EN, Temp Units, Clean, Oven Info, and Auto Cool. A hand icon points to the 'Auto Cool' option, which is circled in red and labeled '3'. A green arrow points to the fourth screenshot, which shows the 'Auto Cool' screen with a timer set to '00 : 00' and a checkmark icon at the bottom right.</p> <p style="text-align: right; font-size: small;">VMC-TS-007976</p>

Continued on next page

Continued from previous page

4. **Touch** the Enable Auto Cool icon ④.

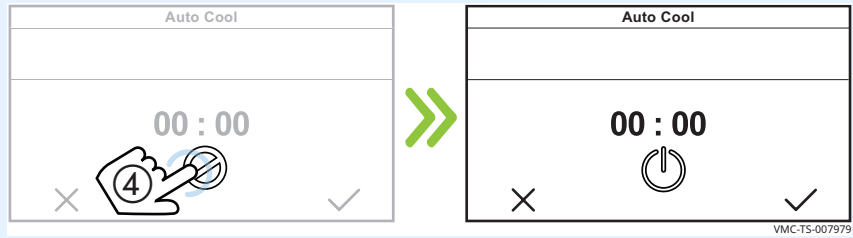

5. **Touch** the hour time setting ⑤. **Enter** the cool down time using the number pad ⑥.

Touch the check mark ⑦.

Repeat the process to set the minute time setting.

Touch the check mark ⑧ to save.

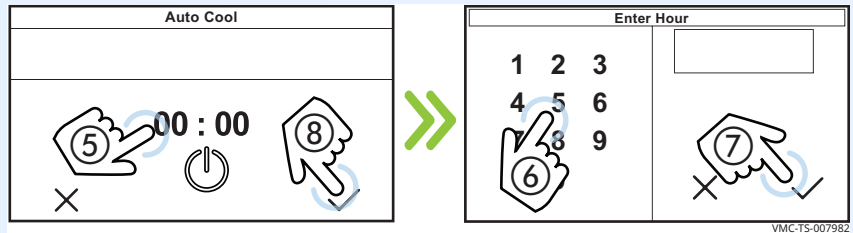

6. **Touch** the back arrows ⑨ and ⑩ to return to the home screen.

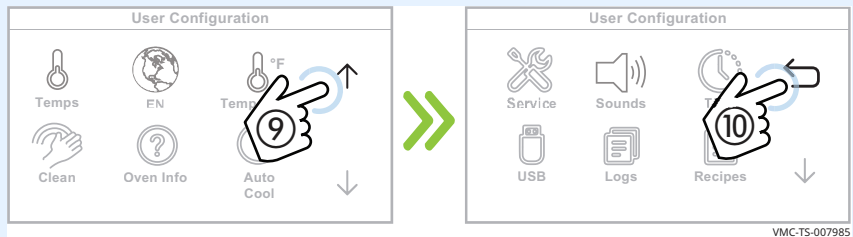

Result

Auto Cool is now enabled.

How to Enable Manual Mode, Linking, and Set Temp Function

Before you begin

- The oven must be turned on (screen is on).
- You will need to know the pass code. The pass code set at the factory is 12345.

Procedure

To enable the Set Temp, Linking, or Manual mode, do the following.

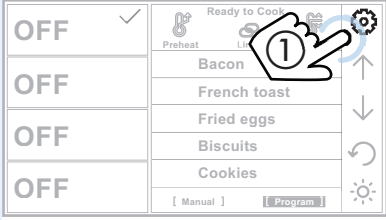
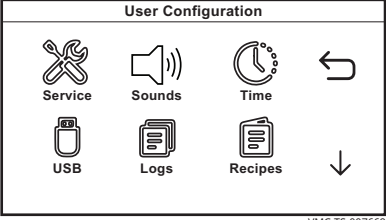
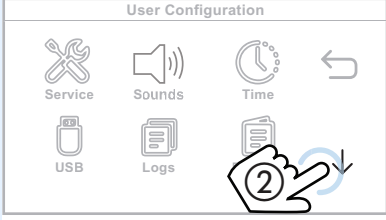
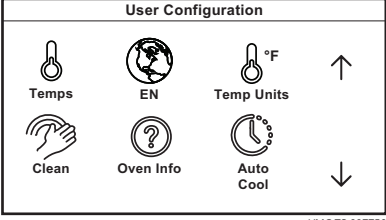
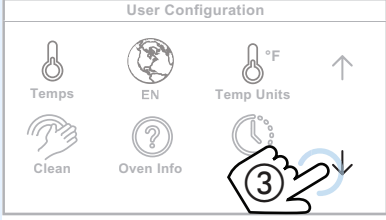
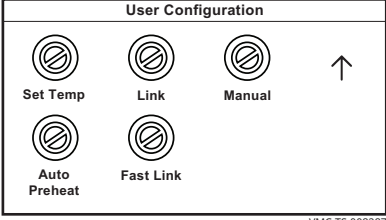
Step	Action
1.	<p>Touch the gear icon ①. The User Configuration screen displays.</p>   <p style="text-align: right; font-size: small;">VMC-TS-007669</p>
2.	<p>Touch the down arrow ②. The second User Configuration screen displays.</p>   <p style="text-align: right; font-size: small;">VMC-TS-007750</p>
3.	<p>Touch the down arrow ③. The third User Configuration screen displays.</p>   <p style="text-align: right; font-size: small;">VMC-TS-008287</p>

Continued on next page

Continued from previous page

4. **Touch** the function you want to enable: Set Temp, Link, or Manual icon ④. The Enter Pass Code screen displays.

Enter the pass code 12345 ⑤. **Touch** the check mark ⑥. The selected function will now be enabled.

Repeat the process to disable the function.

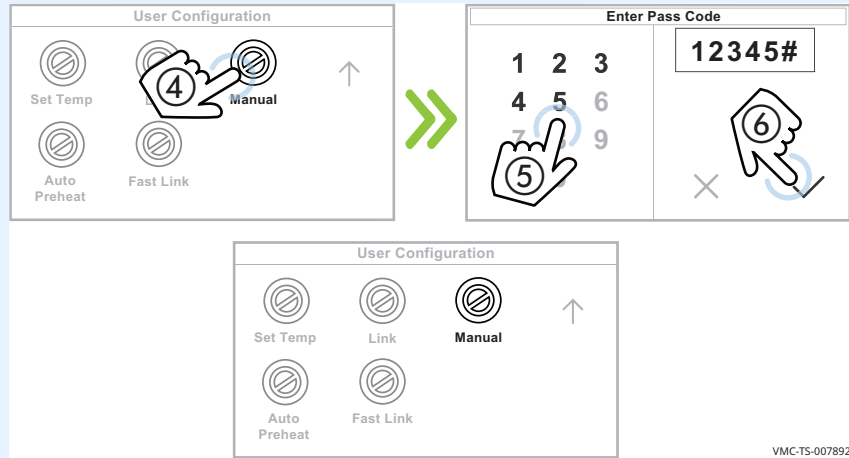

VMC-TS-007892

5. **Touch** the back arrows ⑦ and ⑧ to return to the home screen.

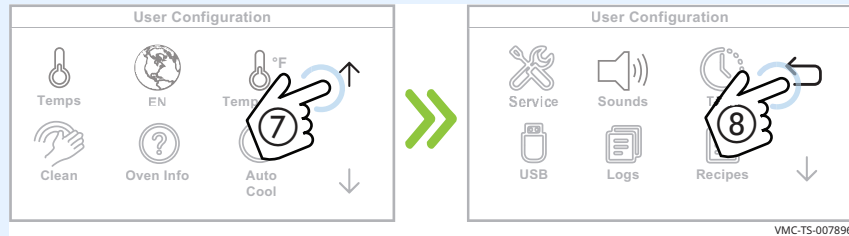

VMC-TS-007896

Result

Set Temp, Linking, or Manual mode is now enabled.

How to Enable Auto Preheat

Before you begin

- The oven must be turned on (screen is on).
- You will need to know the pass code. The pass code set at the factory is 12345.

Background

There may be times when you want the oven to preheat to preset temperatures when the oven is turned on. The Auto Preheat allows you to do so.

Procedure

To enable Auto Preheat, do the following.

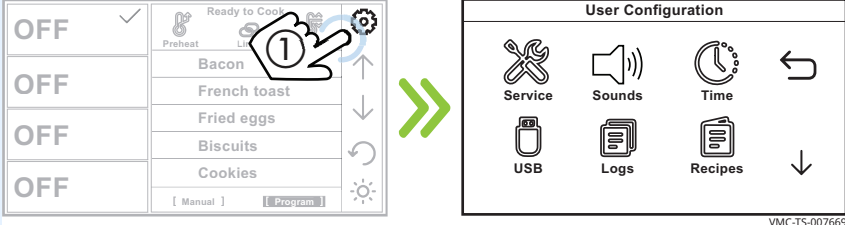
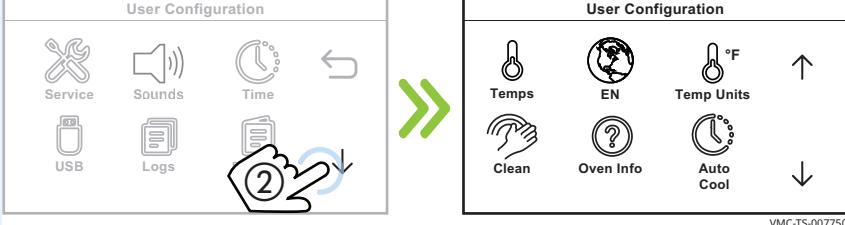
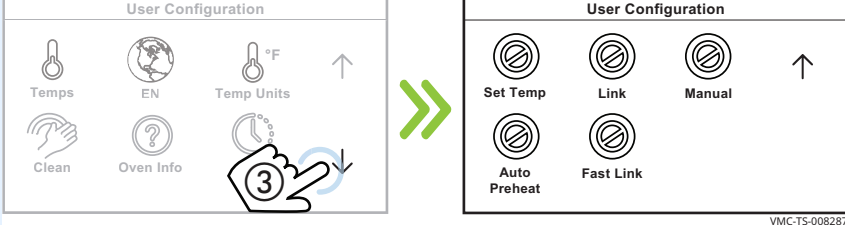
Step	Action
1.	<p>Touch the gear icon ①. The User Configuration screen displays.</p>  <p>The first screenshot shows the oven's main interface with a gear icon circled in red and labeled '1'. A hand icon points to it. A green arrow points to the second screenshot, which shows the 'User Configuration' screen with options: Service, Sounds, Time, USB, Logs, and Recipes. A hand icon points to the gear icon in the top right corner of the main interface.</p>
2.	<p>Touch the down arrow ②. The second User Configuration screen displays.</p>  <p>The second screenshot shows the 'User Configuration' screen with options: Service, Sounds, Time, USB, Logs, and Recipes. A hand icon points to the down arrow in the bottom right corner, labeled '2'. A green arrow points to the third screenshot, which shows a second 'User Configuration' screen with options: Temps, EN, Temp Units, Clean, Oven Info, and Auto Cool. A hand icon points to the down arrow in the bottom right corner of the second screenshot.</p>
3.	<p>Touch the down arrow ③. The third User Configuration screen displays.</p>  <p>The third screenshot shows the 'User Configuration' screen with options: Temps, EN, Temp Units, Clean, Oven Info, and Auto Cool. A hand icon points to the down arrow in the bottom right corner, labeled '3'. A green arrow points to the fourth screenshot, which shows a third 'User Configuration' screen with options: Set Temp, Link, Manual, Auto Preheat, and Fast Link. A hand icon points to the down arrow in the bottom right corner of the third screenshot.</p>

Continued on next page

Continued from previous page

4. **Touch** the Auto Preheat icon ④. The Enter Pass Code screen displays. **Enter** the pass code 12345 ⑤. **Touch** the check mark ⑥. The selected function will now be enabled. **Repeat** the process to disable the function.

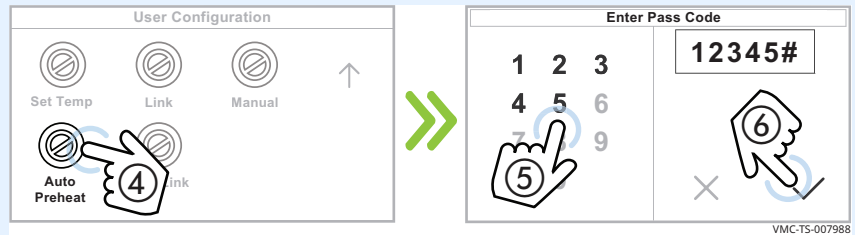

5. **Touch** the back arrows ⑦ and ⑧ to return to the home screen.

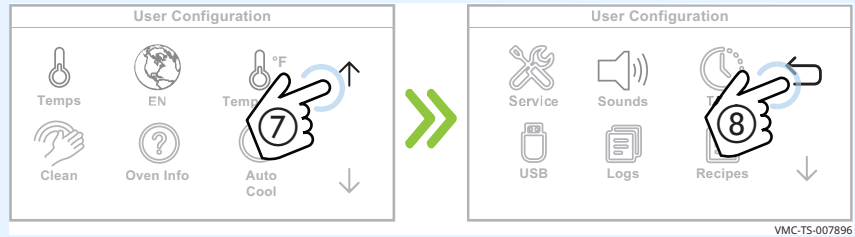

Result

Auto Preheat mode is now enabled.

How to Change the Time and Date Settings

Procedure

To change the time and date settings, do the following.

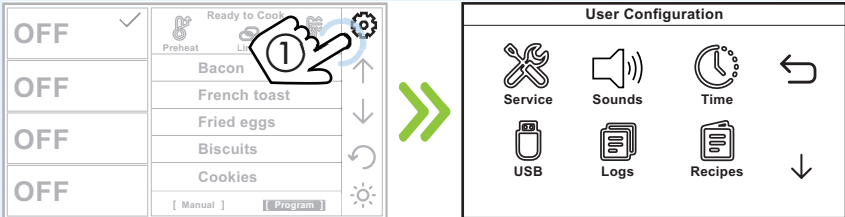
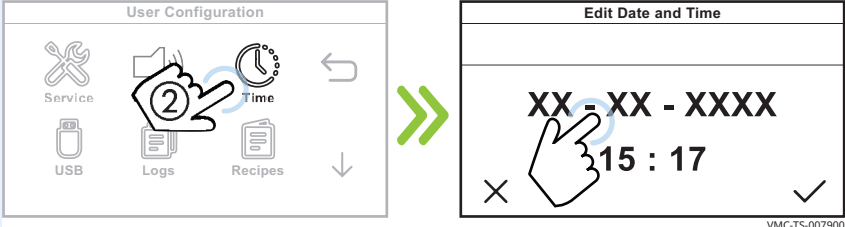
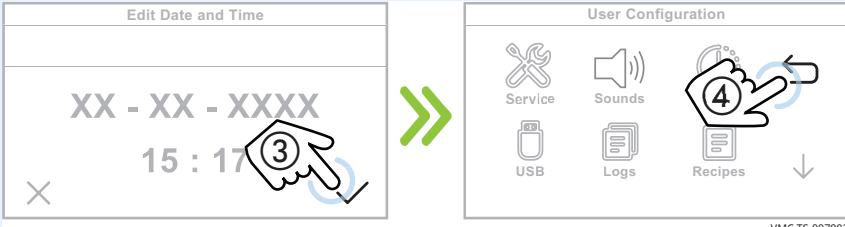
Step	Action
1.	<p>Touch the gear icon ①. The User Configuration screen displays.</p>  <p>VMC-TS-007669</p>
2.	<p>Touch the Time icon ②. The Edit Date and Time screen displays. Follow the prompts to set the time and date.</p>  <p>VMC-TS-007900</p>
3.	<p>Touch the check mark ③ when finished.</p> <p>Touch the back arrow ④ to return to the home screen.</p>  <p>VMC-TS-007903</p>

Result

The time and date have been changed.

How to Change the Sound Settings

Procedure

To change the sound settings, do the following.

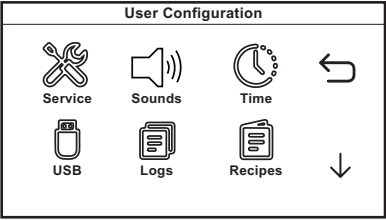
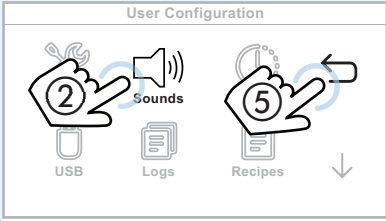
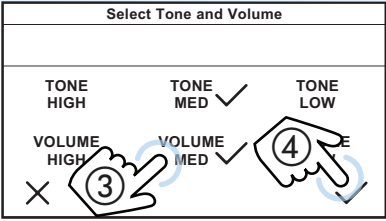
Step	Action
1.	<p>Touch the gear icon ①. The User Configuration screen displays.</p>  
2.	<p>Touch the Sounds icon ②. The Select Tone and Volume screen displays.</p> <p>Touch the tone and volume settings ③.</p> <p>Touch the check mark ④ when finished.</p> <p>Touch the back arrow ⑤ to return to the home screen.</p>  

Result

The sound settings have been changed.

How to Change the Temperature Scale

Procedure

To change the temperature scale from °F to °C and vice versa, do the following.

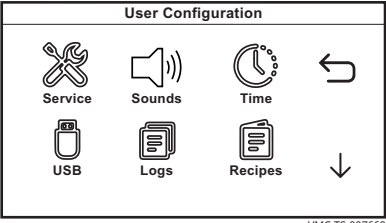
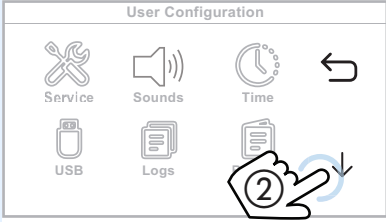
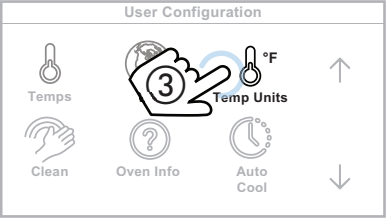
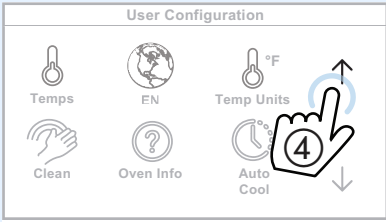
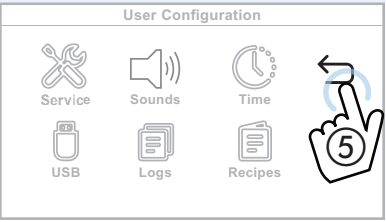
Step	Action
1.	<p>Touch the gear icon ①. The User Configuration screen displays.</p>   <p style="text-align: right; font-size: small;">VMC-TS-007669</p>
2.	<p>Touch the down arrow ②.</p> <p>Touch the Temp Units icon ③ to change the temperature scale.</p>   <p style="text-align: right; font-size: small;">VMC-TS-007911</p> <p>Touch the back arrows ④ and ⑤ to return to the home screen.</p>   <p style="text-align: right; font-size: small;">VMC-TS-007914</p>

Result

The temperature scale has now been changed.

How to Set the Cleaning Timer

Before you begin

To help you remember when to clean the oven, the number of hours until the next cleaning may be programmed into the controller.

Procedure

To set the cleaning timer, do the following.

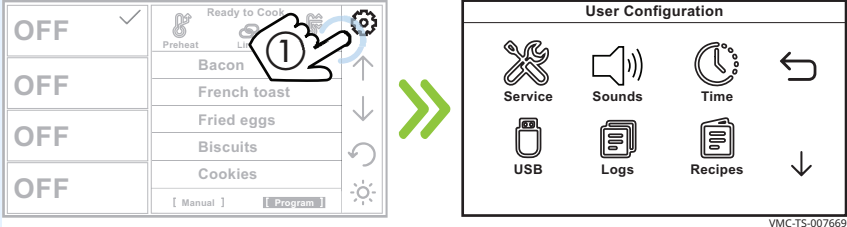
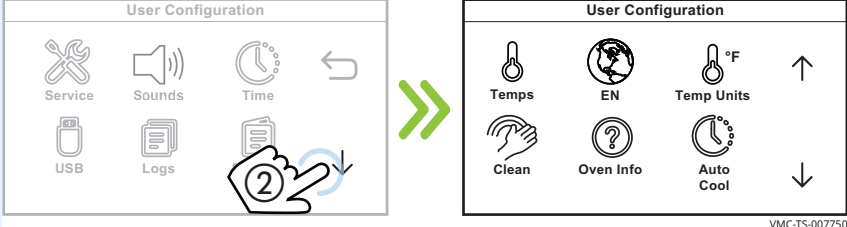
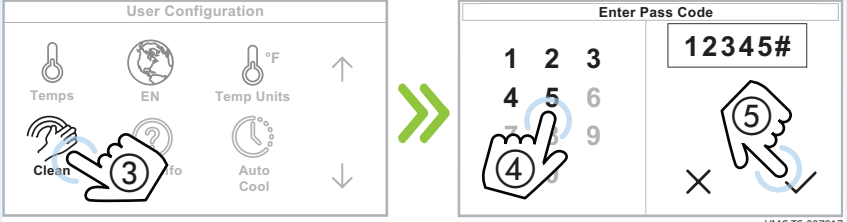
Step	Action
1.	<p>Touch the gear icon ①. The User Configuration screen displays.</p>  <p style="text-align: right; font-size: small;">VMC-TS-007669</p>
2.	<p>Touch the down arrow ②. The second User Configuration screen displays.</p>  <p style="text-align: right; font-size: small;">VMC-TS-007750</p>
3.	<p>Touch the Clean icon ③. The Enter Pass Code screen displays.</p> <p>Enter the pass code 12345 ④.</p> <p>Touch the check mark ⑤.</p>  <p style="text-align: right; font-size: small;">VMC-TS-007917</p>

Continued on next page

Continued from previous page

4. **Enter** the operating hours ⑥ until the oven needs to be cleaned.
Touch the check mark ⑦.

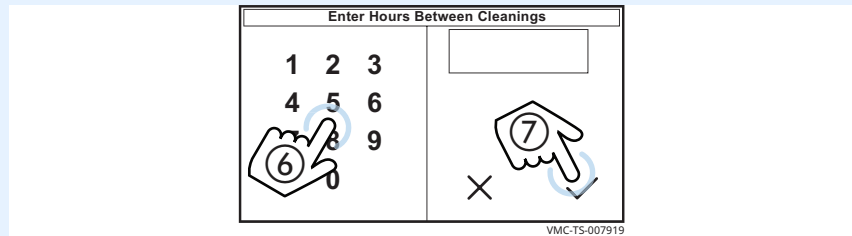

5. **Touch** the up arrow ⑧ then the back arrow ⑨ to return to the home screen.

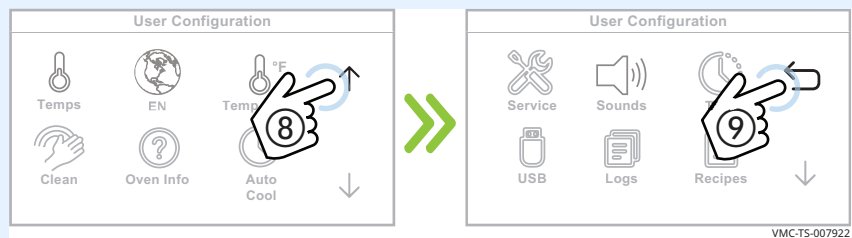

The cleaning timer is now set.

To view the cleaning hours

During the start-up process:

- The screen indicates the number of hours until cleaning is needed.





How to View the Oven Logs

Before you begin

The oven must be turned on (screen is on).

Procedure

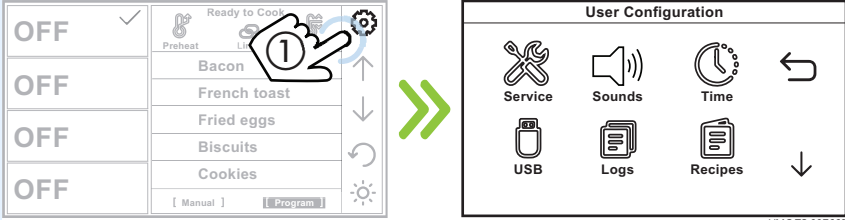
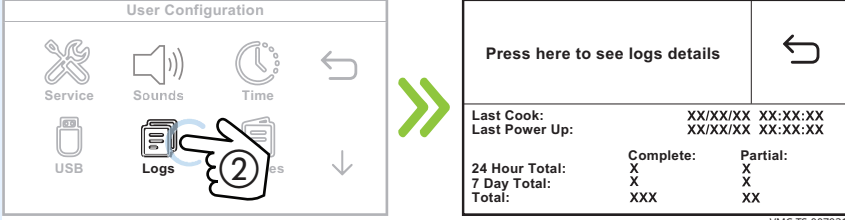
To view the oven logs, do the following.

Step	Action																								
1.	<p>Touch the gear icon ①. The User Configuration screen displays.</p>  <p>The 'User Configuration' screen displays the following options:</p> <table border="1"> <tr> <td>Service</td> <td>Sounds</td> <td>Time</td> <td>←</td> </tr> <tr> <td>USB</td> <td>Logs</td> <td>Recipes</td> <td>↓</td> </tr> </table> <p>VMC-TS-007669</p>	Service	Sounds	Time	←	USB	Logs	Recipes	↓																
Service	Sounds	Time	←																						
USB	Logs	Recipes	↓																						
2.	<p>Touch the Logs icon ②. The Logs Detail screen displays.</p>  <p>The 'Logs Detail' screen displays the following information:</p> <table border="1"> <tr> <td colspan="3">Press here to see logs details</td> <td>←</td> </tr> <tr> <td>Last Cook:</td> <td>XX/XX/XX</td> <td>XX:XX:XX</td> <td></td> </tr> <tr> <td>Last Power Up:</td> <td>XX/XX/XX</td> <td>XX:XX:XX</td> <td></td> </tr> <tr> <td>24 Hour Total:</td> <td>Complete: X</td> <td>Partial: X</td> <td></td> </tr> <tr> <td>7 Day Total:</td> <td>X</td> <td>X</td> <td></td> </tr> <tr> <td>Total:</td> <td>XXX</td> <td>XX</td> <td></td> </tr> </table> <p>VMC-TS-007931</p>	Press here to see logs details			←	Last Cook:	XX/XX/XX	XX:XX:XX		Last Power Up:	XX/XX/XX	XX:XX:XX		24 Hour Total:	Complete: X	Partial: X		7 Day Total:	X	X		Total:	XXX	XX	
Press here to see logs details			←																						
Last Cook:	XX/XX/XX	XX:XX:XX																							
Last Power Up:	XX/XX/XX	XX:XX:XX																							
24 Hour Total:	Complete: X	Partial: X																							
7 Day Total:	X	X																							
Total:	XXX	XX																							
3.	<p>Touch Press here to see log details ③. The logs display.</p> <p>Touch the up and down arrows ④ to scroll through the logs.</p>  <p>The 'Logs' screen displays the following information:</p> <table border="1"> <tr> <td colspan="3">Press here to see logs details</td> <td>←</td> </tr> <tr> <td>Last Cook:</td> <td>XX/XX/XX</td> <td>XX:XX:XX</td> <td></td> </tr> <tr> <td>Last Power Up:</td> <td>XX/XX/XX</td> <td>XX:XX:XX</td> <td></td> </tr> <tr> <td>24 Hour Total:</td> <td>Complete: X</td> <td>Partial: X</td> <td></td> </tr> <tr> <td>7 Day Total:</td> <td>X</td> <td>X</td> <td></td> </tr> <tr> <td>Total:</td> <td>XXX</td> <td>XX</td> <td></td> </tr> </table> <p>The logs list includes:</p> <ul style="list-style-type: none"> XX/XX/XX XX:XX:XX - 3 GRILLED CHIC XX/XX/XX XX:XX:XX - 2 GRILLED CHIC XX/XX/XX XX:XX:XX - 1 GRILLED CHIC XX/XX/XX XX:XX:XX - 2 RAPID COOL 4 XX/XX/XX XX:XX:XX - 4 RAPID COMPLE XX/XX/XX XX:XX:XX - 4 Warm Compl XX/XX/XX XX:XX:XX - 2 RAPID COMPLE XX/XX/XX XX:XX:XX - 2 Warm Compl XX/XX/XX XX:XX:XX - 3 RAPID COMPLE <p>VMC-TS-007934</p>	Press here to see logs details			←	Last Cook:	XX/XX/XX	XX:XX:XX		Last Power Up:	XX/XX/XX	XX:XX:XX		24 Hour Total:	Complete: X	Partial: X		7 Day Total:	X	X		Total:	XXX	XX	
Press here to see logs details			←																						
Last Cook:	XX/XX/XX	XX:XX:XX																							
Last Power Up:	XX/XX/XX	XX:XX:XX																							
24 Hour Total:	Complete: X	Partial: X																							
7 Day Total:	X	X																							
Total:	XXX	XX																							

Continued on next page

Continued from previous page

4. **Touch** the back arrow ⑤ then the back arrow ⑥ to return to the User Configuration screen.

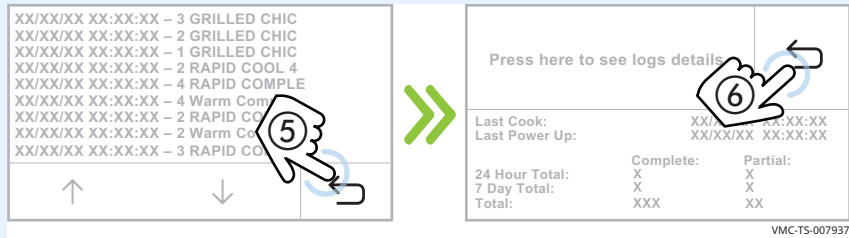

5. **Touch** the back arrow ⑦ to return to the home screen.

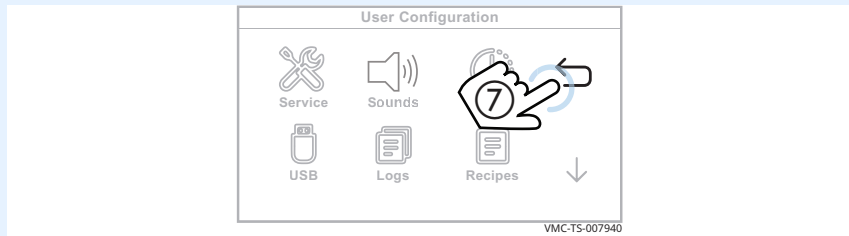

Result

The oven logs have now been viewed.

How to Adjust the Oven Light Duration

Before you begin

The oven must be turned on (screen is on).

Procedure

To adjust the oven light duration, do the following.

Step	Action
------	--------

1. **Touch and hold** the oven light icon ①. The Enter Pass Code screen displays.
Enter the pass code 12345 ②.
Touch the check mark ③.

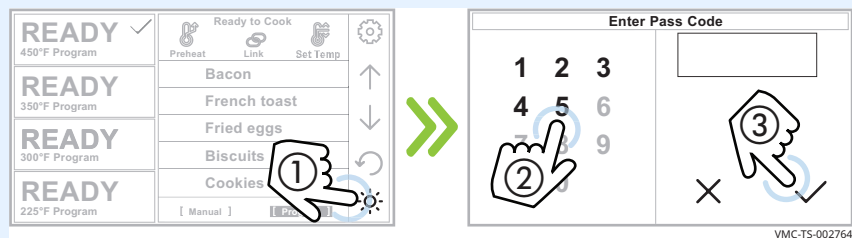

2. **Enter** the number of minutes ④ the oven light will stay on.
Touch the check mark ⑤.

NOTE: Entering zero minutes results in the oven light staying on indefinitely.

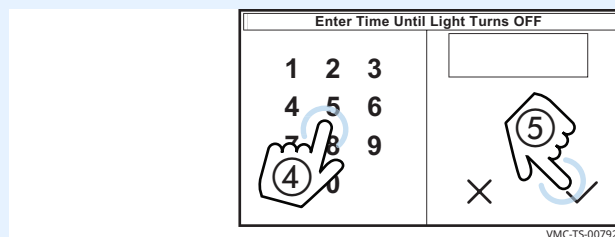

Result

The oven light duration has now been set.

Maintenance Schedule

Requirements

- See topic *How to Clean the Oven*.
- Make sure the oven is cooled down and off—inside of chamber 140°F (60°C) or less.

Daily

For daily maintenance, do the following.

- **Remove** any spills with disposable paper wipes or a damp cloth.
- **Wipe** the outside of the oven with a damp cloth.
- **Check** the screen for cracking or peeling. Contact Technical Service if needed.

Weekly

For weekly maintenance, do the following.

- **Clean** the entire oven. **Make sure** to use a non-abrasive nylon scrub pad.
- Do not spray the cleaner directly into the fan openings located in the rear of the oven.

Monthly

For monthly maintenance, do the following.

- **Inspect** and clean the cooling fan filters.
- **Inspect** and clean the chamber filters (if equipped).

Yearly

For yearly maintenance, do the following.



NOTE: Must be performed by a qualified professional.

- **Check and tighten** all wire connections.
- **Inspect** the heater flange area for grease leakage.
- **Inspect** the motor flange area for grease leakage.
- **Check and tighten** all display, interface and control board connections.
- **Check and tighten** the door hinges.
- **Inspect** the inner and outer door window panes for cracking or chipping.
- **Test** each chamber fan for correct operation.
- **Test** each chamber heater for correct operation.
- **Test** the chamber lights.
- **Record** the software versions and update if necessary.
- **Inspect** the door gaskets for correct shape and seal.
- **Record** the amp draw of all elements on the service screen individually.
- **Record** the incoming supply line voltage.

How to Clean the Oven

Before you begin



WARNING: Electric shock hazard.
Set the main disconnect switch to the OFF position to remove electric power from the appliance.



CAUTION: Burn hazard.
Allow the oven, utensils, and racks to cool before cleaning.



CAUTION: Corrosive materials hazard.
Wear eye protection and hand protection when cleaning.

NOTICE

Using improper cleaning procedures will damage the catalyst and void the warranty.
Only use spray cleaner when the electric power is completely removed from the oven.
Do not spray water or cleaning solution on the catalyst.
Do not spray cleaner into the oven while the recirculation blower is running.
Do not use steel pads, wire brushes, or scrapers when cleaning.

Daily cleaning procedure

To clean the oven daily, do the following.

Step	Action
1.	Make sure the oven is turned off and cool—chambers are less than 140°F (60°C).
2.	Remove any spills with disposable paper wipes or a damp cloth.
3.	Wipe the outside of the oven with a damp cloth.
4.	Wipe the outside of the oven with a stainless steel cleaner.

Continued on next page

Continued from previous page

Weekly cleaning procedure

To clean the oven weekly, do the following.

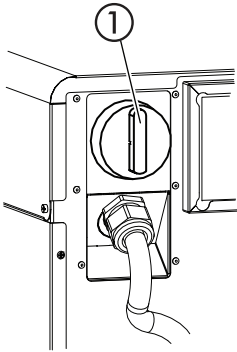
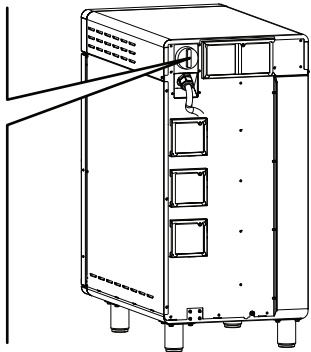
Step	Action
1.	<p>Set the main disconnect switch ① to the OFF position.</p> <p>Make sure the oven is cool—chambers are less than 140°F (60°C).</p> <div style="display: flex; justify-content: space-around; align-items: center;">   </div> <p style="text-align: right; font-size: small;">VMC-TS-006236</p>
2.	<p>Spray the exterior areas of the oven with stainless steel polish.</p> <div style="border: 1px solid blue; padding: 5px; margin-top: 10px;"> <p>NOTICE Use only non-caustic cleaners. Do not spray directly into the fan openings on the rear of the oven. Do not use cleaners that contain sodium hydroxide (lye) or phosphorus.</p> </div>
3.	Wipe the exterior areas of the oven with a non-abrasive nylon scrub pad.
4.	Spray the interior areas of the oven with EcoLab Greaselift™ or Chemco Dirt Buster III™ oven cleaner. Let the cleaner work for 3-5 minutes.
5.	Wipe the interior of the oven with a non-abrasive nylon scrub pad.
6.	Clean each side of the window pane with an all-purpose cleaner.
7.	Set the main disconnect switch ① to the ON position when complete.

Continued on next page

Continued from previous page

Monthly cleaning procedure

To clean the oven monthly, do the following.

Step	Action
------	--------

- | | |
|----|--|
| 1. | Set the main disconnect switch to the OFF position.
Make sure the oven is cool—chambers are less than 140°F (60°C). |
|----|--|

- | | |
|----|---|
| 2. | Remove the cooking racks ① and jet plates ②. |
|----|---|



CAUTION: Personal injury hazard.
Use hand protection when handling the jet plates.

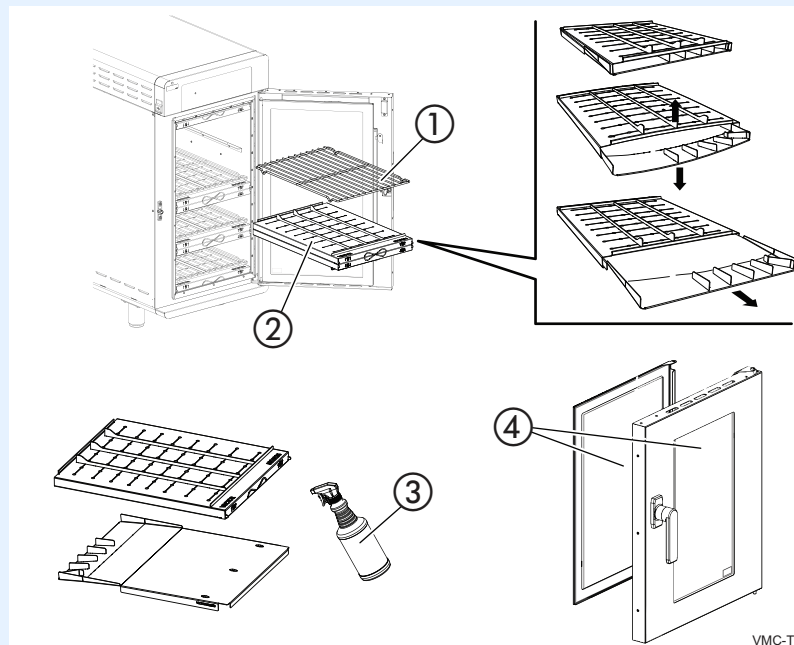

VMC-TS-006244

- | | |
|----|--|
| 3. | Separate the jet plates. Flexing the jet plates outward can aid in separating the jet plates. |
| 4. | Spray the jet plates with EcoLab Greaselift™ or Chemco Dirt Buster III™ ③ oven cleaner. Let the cleaner work for 3–5 minutes. Follow safety instructions on cleaner bottle. |
| 5. | Scrub the jet plates with a non-abrasive nylon scrub pad. Rinse the jet plates with water. |
| 6. | Spray a towel with EcoLab Greaselift™ or Chemco Dirt Buster III™ then wipe the inside of the oven. Remove any residue with a water-soaked towel. |
| 7. | Clean the door glass ④ with Windex® or equivalent glass cleaner. |

Continued on next page

Continued from previous page

8. **Re-install** the jet plates and cooking racks.

i **NOTE:** Make sure the jet plates are installed correctly. The nozzles on the jet plates should be pointing towards the food.

**Cleaning the filters
(if equipped)**

9. **Remove** the filters **5**.

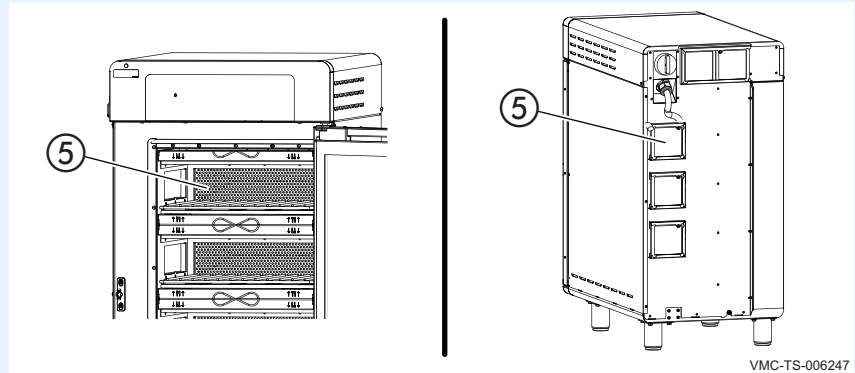

10. **Spray** the filters with a mild cleaner and rinse with hot water.

i **NOTE:** Replace the filters at least once a year.

11. **Re-install** the filters.

12. **Set** the main disconnect switch to the ON position when complete.

Result

The oven is now clean.

This page intentionally left blank.

What to do if the Fan Indicator Light Illuminates

Procedure

If the fan indicator light ① illuminates, do the following.

Step	Action
1.	<p>Turn off the oven and allow it to cool.</p> <p>Remove the filters ②.</p> <div data-bbox="537 592 1380 1005" data-label="Image"> </div>
2.	Clean the filters in a dishwasher.
3.	Re-install the filters.
4.	Resume operation of the oven.
<p>NOTE: If the fan indicator light remains on, the appliance is malfunctioning. Disconnect the appliance from the power supply and have it serviced by a qualified technician.</p>	

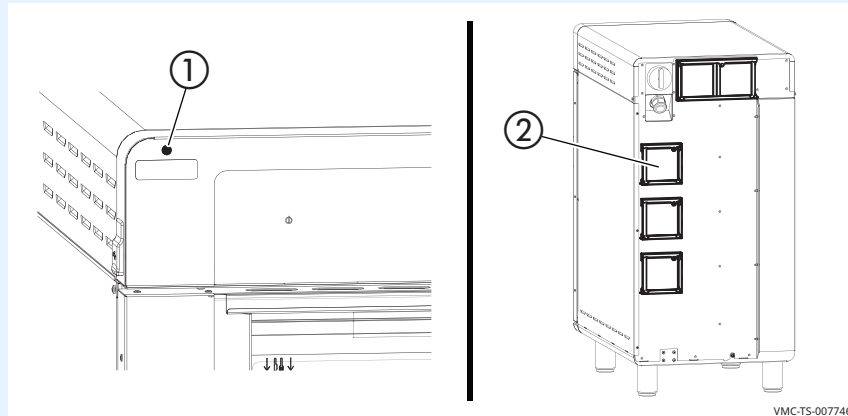



Result

The procedure is now complete.

What to do if the High Limit Screen Displays

Procedure

If the high limit screen displays, do the following.

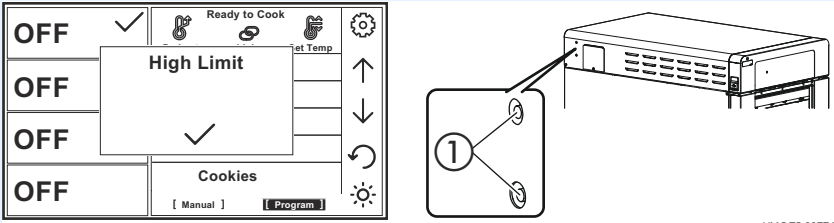
Step	Action
1.	<p>Press and release the high limit temperature reset button(s) ①.</p>  <p style="text-align: right; font-size: small;">VMC-TS-007743</p>
2.	<p>Resume operation of the oven.</p> <div style="border: 1px solid black; padding: 5px; margin-top: 10px;"> <p>NOTE: If the high limit screen continues to display, the appliance is malfunctioning. Turn off the appliance and have the oven serviced by a qualified technician.</p> </div>

Result

The procedure is now complete.

Warranty

Introduction

Alto-Shaam, Inc. warrants to the original purchaser only, that any original part found to be defective in material or workmanship will be replaced with a new or rebuilt part at Alto-Shaam's option, subject to provisions hereinafter stated.

Warranty Period

The original parts warranty period is as follows:

- For all other original parts, one (1) year from the date of installation of appliance or fifteen (15) months from the shipping date, whichever occurs first.
- The labor warranty period is one (1) year from the date of installation or fifteen (15) months from the shipping date, whichever occurs first.
- Alto-Shaam will bear normal labor charges performed during standard business hours, excluding overtime, holiday rates or any additional fees.
- For the refrigeration compressor, if installed, the warranty period is five (5) years from the date of original installation of the appliance.
- For heating elements on Halo Heat® Cook and Hold ovens, the warranty period is for as long as the original owner owns the oven. This warranty period applies to units sold after 2/1/2009 and excludes holding-only ovens.
- To be valid, a warranty claim must be asserted during the applicable warranty period. This warranty is not transferable.

Exclusions

This warranty does not apply to:

- Calibration.
- Replacement of light bulbs, rubber gaskets, grease filters, air filters, racks, jet plates, and/or the replacement of glass due to damage of any kind.
- Equipment damage caused by accident, shipping, improper installation or alteration.
- Equipment used under conditions of abuse, misuse, carelessness or abnormal conditions, including but not limited to, equipment subjected to harsh or inappropriate chemicals, including but not limited to, compounds containing chloride or quaternary salts, poor water quality, or equipment with missing or altered serial numbers.
- Equipment damage caused by use of any cleaning agents other than those recommended by Alto-Shaam, including but not limited to damage due to chlorine or other harmful chemicals.
- Any losses or damage resulting from malfunction, including loss of food product, revenue, or consequential or incidental damages of any kind.
- Equipment modified in any manner from original model, substitution of parts other than factory authorized parts, unauthorized removal of any parts including legs, or unauthorized addition of any parts.

Continued on next page

WARRANTY

Continued from previous page

- Equipment damage incurred as a direct result of poor water quality*, inadequate maintenance of steam generators and/or surfaces affected by water. Water quality and required maintenance of steam generating equipment is the responsibility of the owner/operator.
 - Equipment damage incurred as a result of not following the required maintenance schedule published in the manuals for the equipment.
-

Conclusion

This warranty is exclusive and is in lieu of all other warranties, express or implied, including the implied warranties of merchantability and fitness for a particular purpose. No person except an officer of Alto-Shaam, Inc. is authorized to modify this warranty or to incur on behalf of Alto-Shaam any other obligation or liability in connection with Alto-Shaam equipment.

**Refer to the product spec sheet for water quality standards.*



ALTO-SHAAM ASIA
Shanghai, China
Phone +86-21-6173 0336

ALTO-SHAAM CANADA
Concord, Ontario Canada
Toll Free Phone 866-577-4484
Phone +1-905-660-6781

**ALTO-SHAAM CENTRAL
& SOUTH AMERICA**
Miami, FL USA
Phone +1-954-655-5727

**ALTO-SHAAM MIDDLE EAST
& AFRICA**
Dubai, UAE
Phone +971 4 321 9712

ALTO-SHAAM MEXICO
Phone +52 1 477-717-3108

ALTO-SHAAM FRANCE, L.L.C.
Aix en Provence, France
Phone +33(0)4-88-78-21-73

ALTO-SHAAM GMBH
Bochum, Germany
Phone +49(0)234-298798-0

ALTO-SHAAM RUSSIA
Moscow, Russia
Phone +7-903-793-2331

ALTO-SHAAM.

Menomonee Falls, WI 53052-0450, U.S.A.
Telephone 800-558-8744 | +1-262-251-3800 | alto-shaam.com